

Mathematics Blackline Masters

**for use with
Atlantic Canada Mathematics
Curriculum Guide
Mathematics Essentials 11**

© Crown Copyright, Province of Nova Scotia 2003
Prepared by the Department of Education

Contents of this publication and electronic versions of this publication may be reproduced in whole or in part for the use of Nova Scotia teachers of the Public School Program and full acknowledgement is given to the Nova Scotia Department of Education.

Please note that all attempts have been made to identify and acknowledge information from external sources. In the event that a source was overlooked, please contact English Program Services, Nova Scotia Department of Education at eps@ednet.ns.ca.

ACKNOWLEDGEMENTS

The Department of Education gratefully acknowledges the contributions of the following individuals to the preparation of this resource.

Nova Scotia Department of Education

Nancy Chisholm

Donna Karsten

Annapolis Valley Regional School Board

Martha Stewart

Jim Pulsifer

Aldershot Elementary School

Linda Eaton

Berwick and District School

Dorothy King

Bridgetown Regional Elementary School

Kathy McOrmand

Krista Wright

Coldbrook and District School

June Brown

Lynn Campbell

Carter Creaser

Kings County Academy

Gail Jones

Kingston District School

Jill MacDonald

Jason Spinney

New Minas Elementary School

Janice Wheaton

Port Williams Elementary School

Anne Mac Kenzie

St. Mary's Elementary School

Kelly Ward

Table of Contents

Folder on CD	Blackline Master Title	Page #	File name (MS Word)	File name (PDF)
base_10_blocks	Base 10 Blocks (all)	1	base10_all.doc	base10_all.pdf
	Base Ten Grid Paper	2	base10_grid.doc	base10_grid.pdf
	Base 10 Blocks (hundreds)	3	base10_hundreds.doc	base10_hundreds.pdf
	Base 10 Blocks (tens and ones)	4	base10_tens_ones.doc	base10_tens_ones.pdf
	Base 10 Blocks (thousands)	5	base10_thousands.doc	base10_thousands.pdf
calendars	Calendar 1	6	calendar1.doc	calendar1.pdf
	Calendar 2	7	calendar2.doc	calendar2.pdf
decimals	Decimal Squares	8	decimal_squares.doc	decimal_squares.pdf
	Decimal Squares (wholes to thousandths)	9 – 12	decimal_squares_sets.doc	decimal_squares_sets.pdf
dot_paper	Isometric Dot Paper (1 cm)	13	iso_dot_1cm.doc	iso_dot_1cm.pdf
	Isometric Dot Paper (2 cm)	14	iso_dot_2cm.doc	iso_dot_2cm.pdf
	Square Dot Paper (0.5 cm)	15	sq_dot_0.5cm.doc	sq_dot_0.5cm.pdf
	Square Dot Paper (1 cm)	16	sq_dot_1cm.doc	sq_dot_1cm.pdf
	Square Dot Paper (2 cm)	17	sq_dot_2cm.doc	sq_dot_2cm.pdf
	Triangle Dot Paper	18	triangle_dot.doc	triangle_dot.pdf
fraction_circles	Fraction Circles (to sixteenths labelled)	19	to_sixteenths_labelled.doc	to_sixteenths_labelled.pdf
	Fraction Circles (to sixteenths unlabelled)	20	to_sixteenths_unlabelled.doc	to_sixteenths_unlabelled.pdf
fraction_strips	Fraction Strips (to sixteenths labelled)	21	fs_to_sixteenths_labelled.doc	fs_to_sixteenths_labelled.pdf
	Fraction Strips (to sixteenths unlabelled)	22	fs_to_sixteenths_unlabelled.doc	fs_to_sixteenths_unlabelled.pdf
geometry_2D	Pythagorean Theorem	23	pythagorean.doc	pythagorean.pdf

Folder on CD	Blackline Master Title	Page #	File name (MS Word)	File name (PDF)
geometry_3D				
isometric_drawings	Isometric Drawings 1	24	isometric_drawings1.doc	isometric_drawings1.pdf
nets	Isometric Drawings 2	25	isometric_drawings2.doc	isometric_drawings2.pdf
	Net (closed cylinder)	26	net_closed_cyl.doc	net_closed_cyl.pdf
	Net (open cylinder)	27	net_open_cyl.doc	net_open_cyl.pdf
	Net (rectangular prism)	28	net_rect_prism.doc	net_rect_prism.pdf
	3-D Skeletons	29 – 30	3D_skeletons.doc	3D_skeletons.pdf
grid_paper				
	Grids (10 x 10)	31	10x10_grids.doc	10x10_grids.pdf
	Grid Paper (0.5 cm)	32	grid_paper_0.5.doc	grid_paper_0.5.pdf
	Grid Paper (1.0 cm)	33	grid_paper_1.0.doc	grid_paper_1.0.pdf
	Grid Paper (2.0 cm)	34	grid_paper_2.0.doc	grid_paper_2.0.pdf
	Ten Thousands Grid	35	ten_thousands_grid.doc	ten_thousands_grid.pdf
measurement				
thermometers				
	Thermometers 1	36	thermometers1.doc	thermometers1.pdf
	Thermometers 2	37	thermometers2.doc	thermometers2.pdf
	Thermometers 3	38	thermometers3.doc	thermometers3.pdf
	Number Strips (100 cm)	39	100cm_strips.doc	100cm_strips.pdf
	Measurement Recording Sheet	40	measurement_record_sheet.doc	measurement_record_sheet.pdf
	Protractors	41	protractors.doc	protractors.pdf
	Rulers (6 in)	42	rulers_6in.doc	rulers_6in.pdf
	Rulers (1.5 cm)	43	rulers_15cm.doc	rulers_15cm.pdf
miscellaneous				
	Bar Graph	44	bar_graph.doc	bar_graph.pdf
	Hundredths Disk	45	hundredths_disk.doc	hundredths_disk.pdf
money				
	Canadian Currency (bills)	46	canada_bills.doc	canada_bills.pdf
	Canadian Currency (coins)	47 – 49	canada_coins.doc	canada_coins.pdf

Folder on CD	Blackline Master Title	Page #	File name (MS Word)	File name (PDF)
multiplication_charts	Multiplication Chart (12 x 20) Multiplication Chart (blank) Multiplication Chart (fill in) Multiplication Chart (missing number 1) Multiplication Chart (missing number 2)	50 51 52 53 54	mult_chart_12x20.doc mult_chart_blank.doc mult_chart_fillin.doc mult_chart_missing1.doc mult_chart_missing2.doc	mult_chart_12x20.pdf mult_chart_blank.pdf mult_chart_fillin.pdf mult_chart_missing1.pdf mult_chart_missing2.pdf
number_cubes	Number Cube (blank) Number Cube (dots) Number Cube (numbers)	55 56 57	number_cube_blank.doc number_cube_dots.doc number_cube_numbers.doc	number_cube_blank.pdf number_cube_dots.pdf number_cube_numbers.pdf
number_lines	Fraction Number Lines (sixteenths) Fraction Number Lines (tenths) Fraction Number Lines (twelfths) Number Line (vertical with -1, 0, +1) Number Line (vertical blank) Number Line (vertical integers) Number Lines (blank) Number Lines (based on sixteenths) Number Lines (based on tenths)	58 59 60 61 62 63 64 65 66	fraction_lines_sixteenths.doc fraction_lines_tenths.doc fraction_lines_twelfths.doc number_line_vert_0.doc number_line_vert_blank.doc number_line_vert_integer.doc number_lines_blank.doc number_lines_sixteenths.doc number_lines_tenths.doc	fraction_lines_sixteenths.pdf fraction_lines_tenths.pdf fraction_lines_twelfths.pdf number_line_vert_0.pdf number_line_vert_blank.pdf number_line_vert_integer.pdf number_lines_blank.pdf number_lines_sixteenths.pdf number_lines_tenths.pdf
place_value_charts	Place Value Chart (to tens) Place Value Chart (to hundreds) Place Value Chart (to thousands) Place Value Chart (to hundred thousands) Place Value Chart (to millions) Place Value Chart (to tenths) Place Value Chart (to hundredths) Place Value Chart (to thousandths)	67 68 69 70 71 72 73 74	01_to_tens.doc 02_to_hundreds.doc 03_to_thousands.doc 04_to_hundred_thousands.doc 05_to_millions.doc 06_to_tenths.doc 07_to_hundredths.doc 08_to_thousandths.doc	01_to_tens.pdf 02_to_hundreds.pdf 03_to_thousands.pdf 04_to_hundred_thousands.pdf 05_to_millions.pdf 06_to_tenths.pdf 07_to_hundredths.pdf 08_to_thousandths.pdf
symmetry	Symmetry (bug) Symmetry (car) Symmetry (house)	75 76 77	symmetry_bug.doc symmetry_car.doc symmetry_house.doc	symmetry_bug.pdf symmetry_car.pdf symmetry_house.pdf

Base 10 Blocks (all)

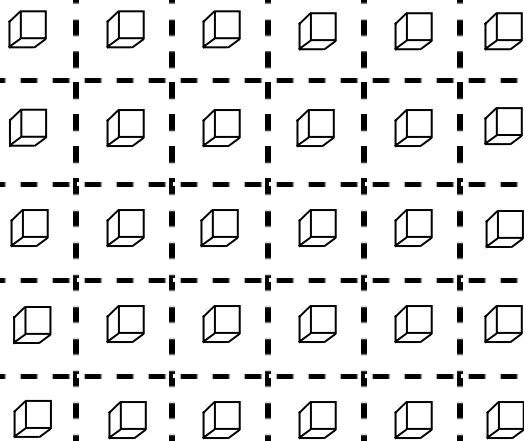
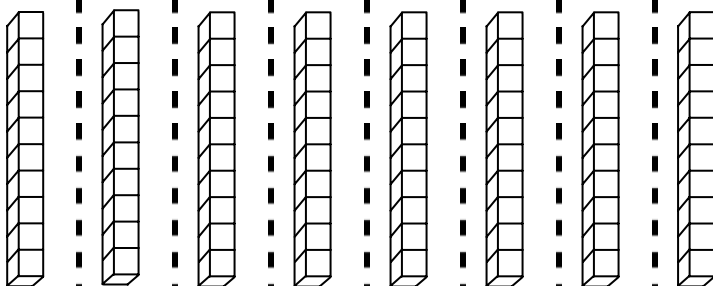
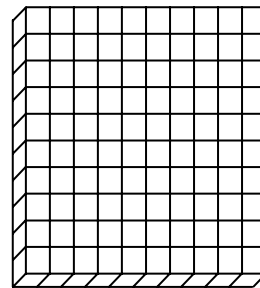
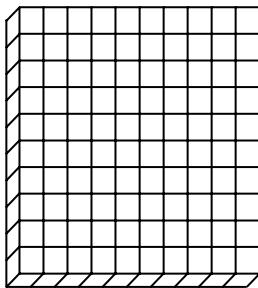
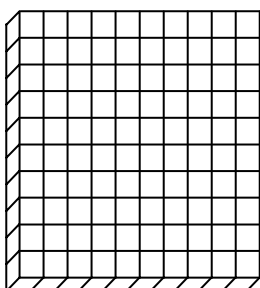
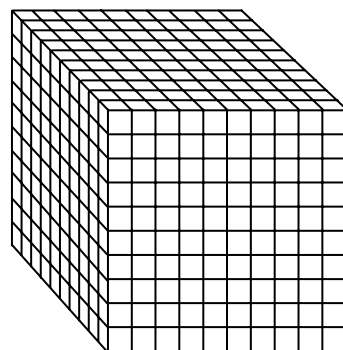
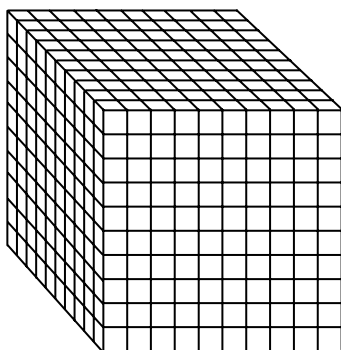
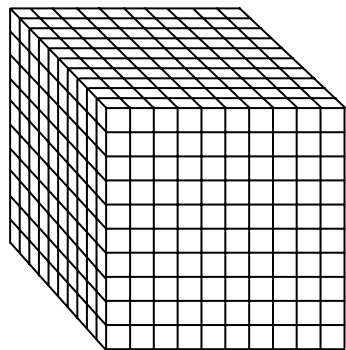

Base Ten Grid Paper

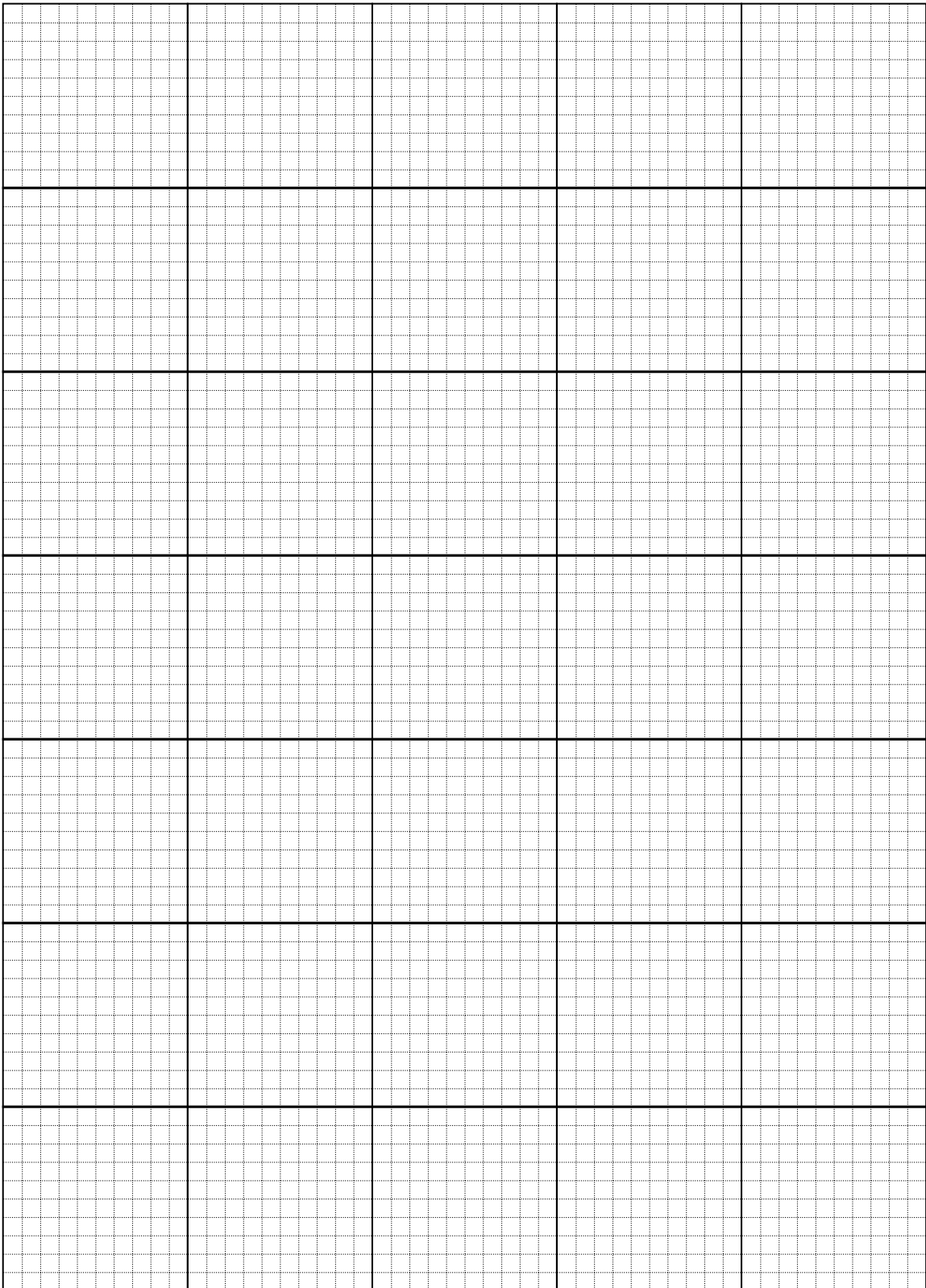

Base 10 Blocks (hundreds)

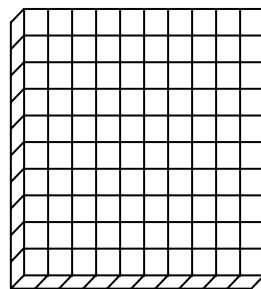
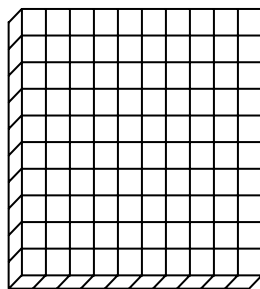
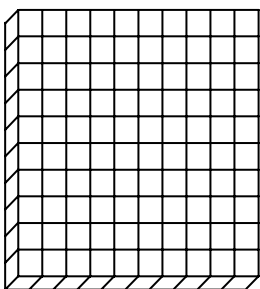
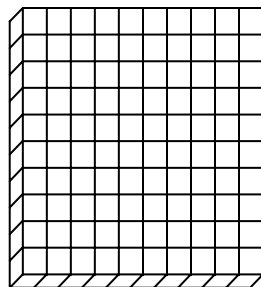
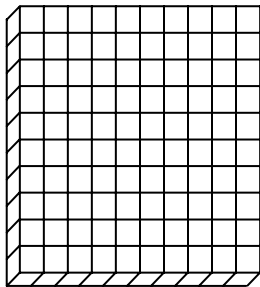
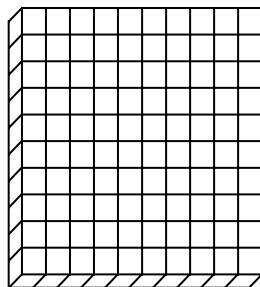
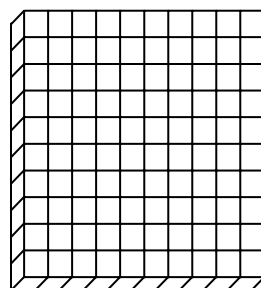
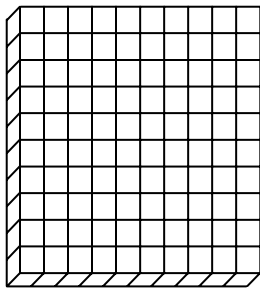
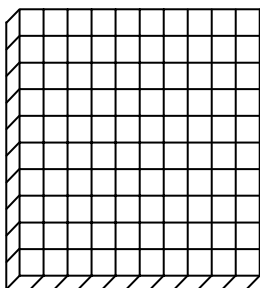

Base 10 Blocks (tens and ones)

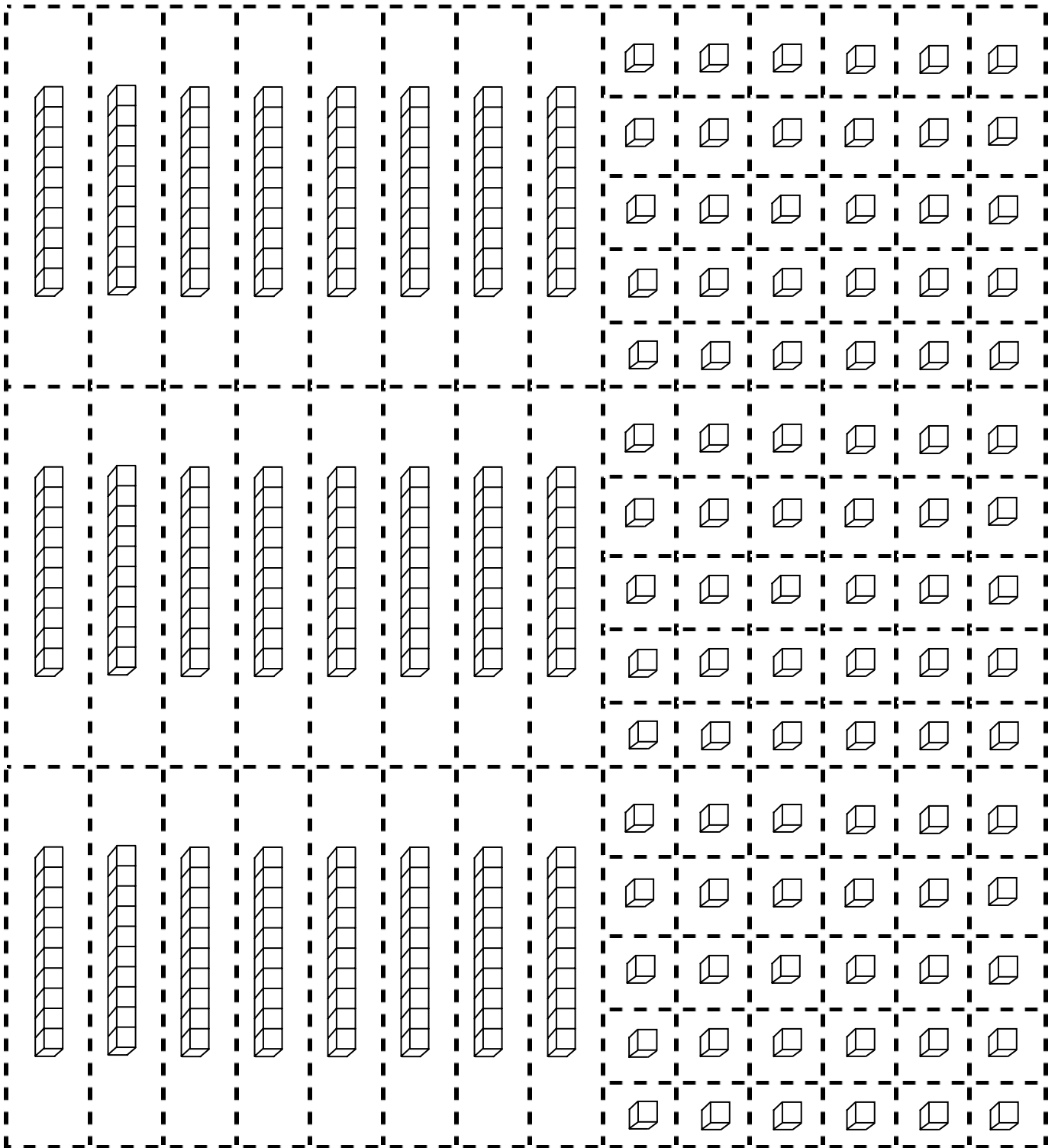

Base 10 Blocks (thousands)

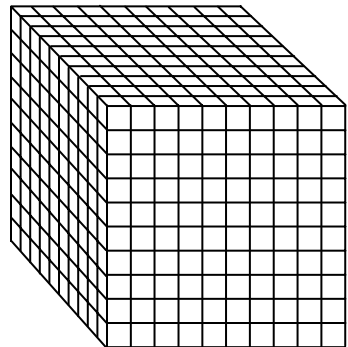
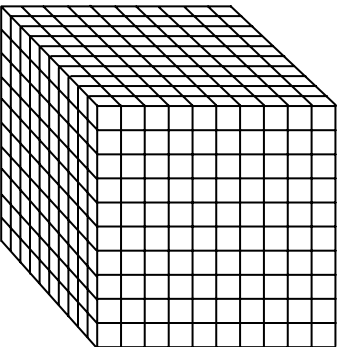
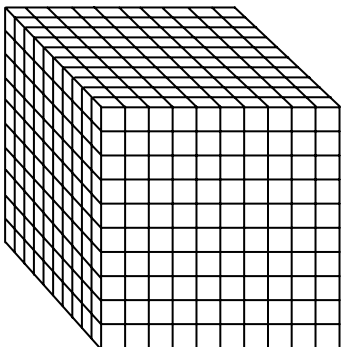
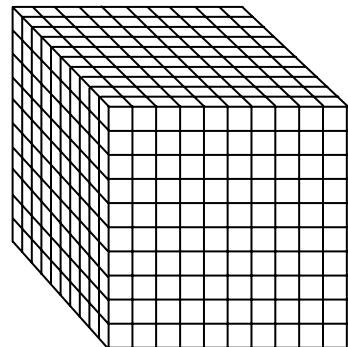
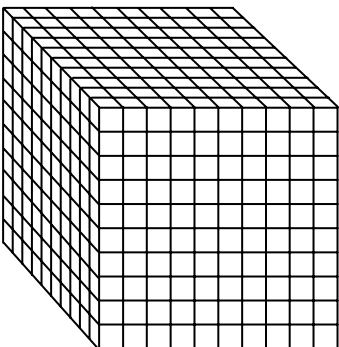
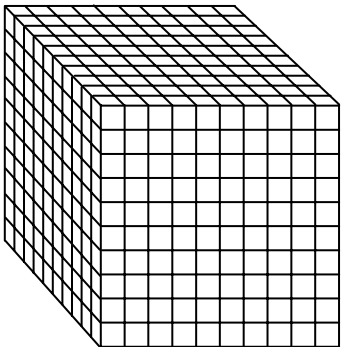
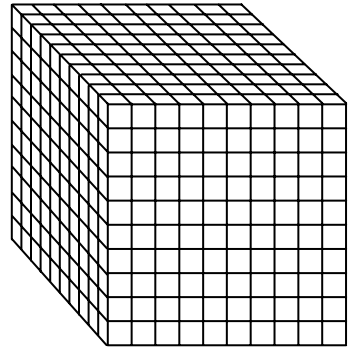
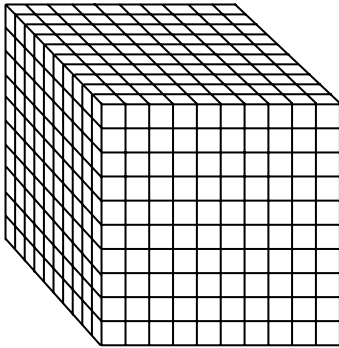
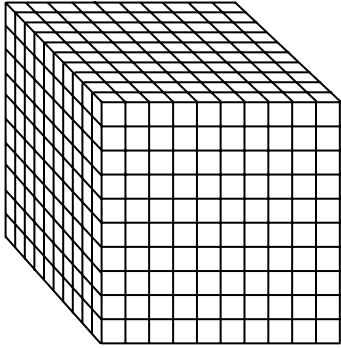

Calendar 1

Month: _____

Year: _____

Sunday	Monday	Tuesday	Wednesday	Thursday	Friday	Saturday

Calendar 2

Month: _____					
Year: _____					

Decimal Squares

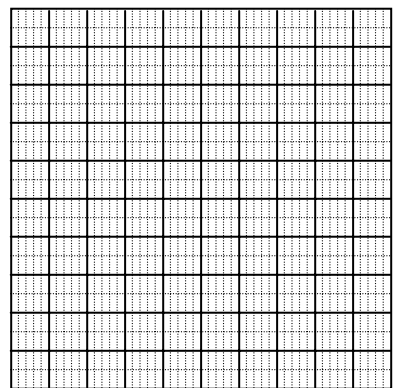
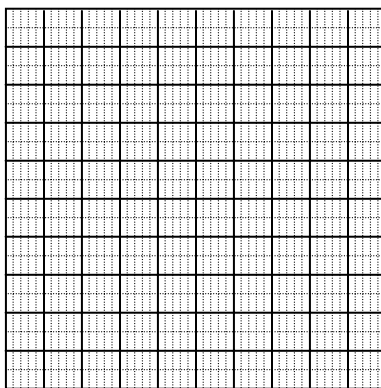
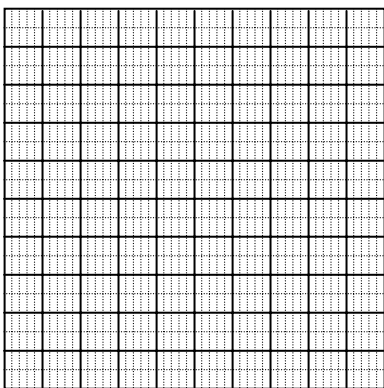
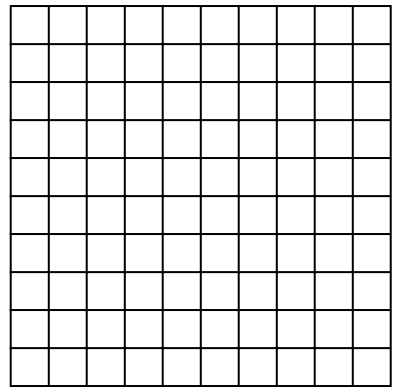
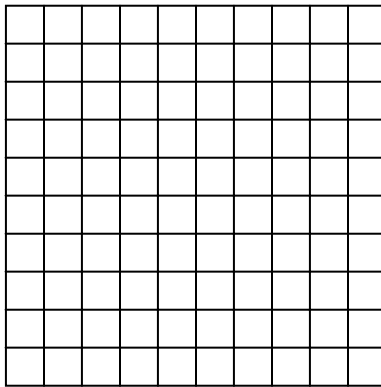
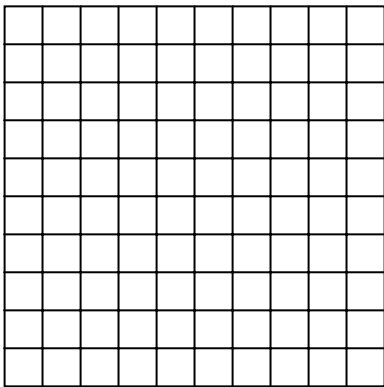
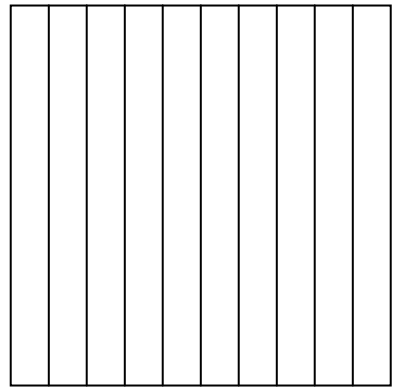
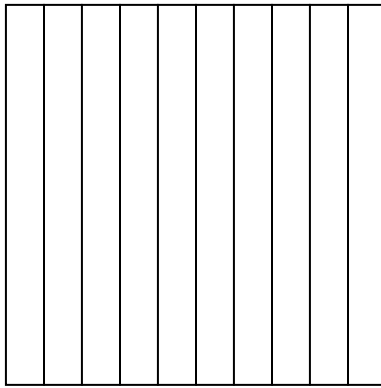
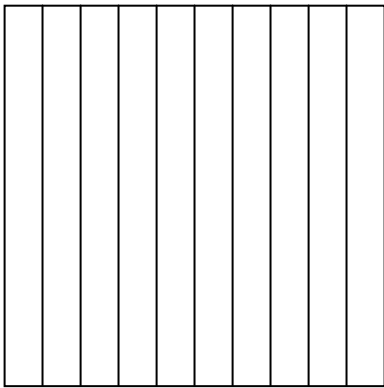
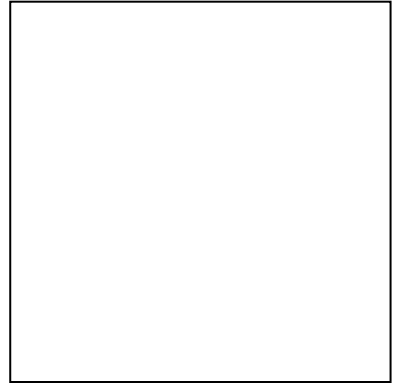
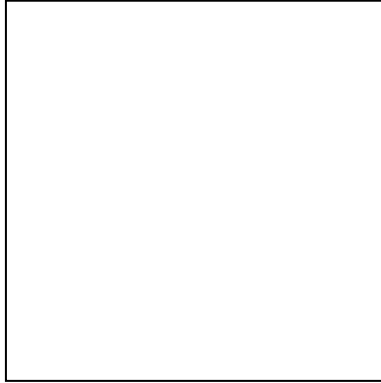
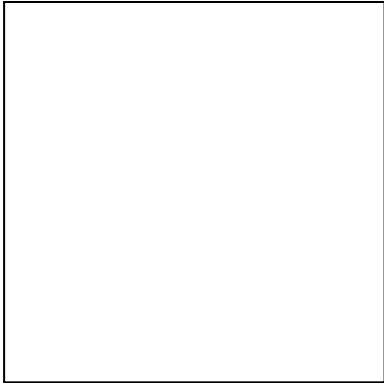

Decimal Squares (wholes)

Decimal Squares (tenths)

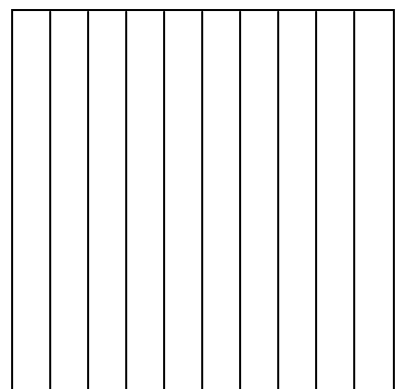
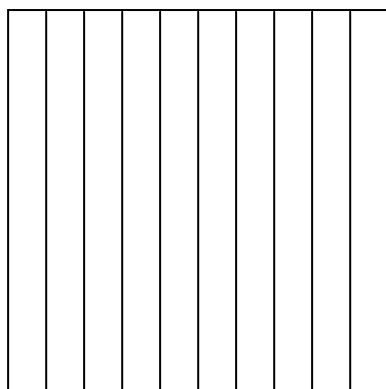
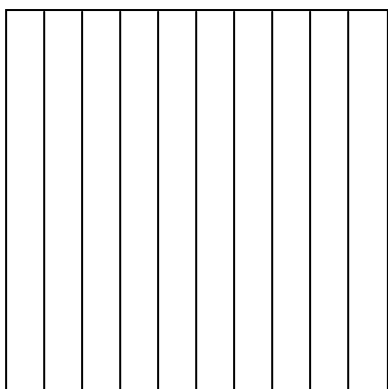
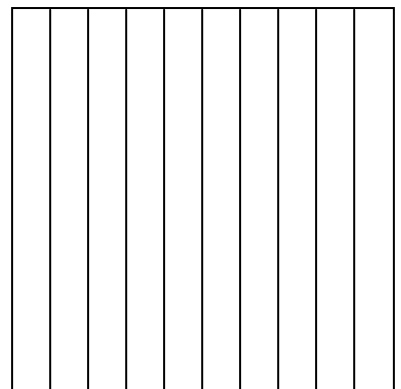
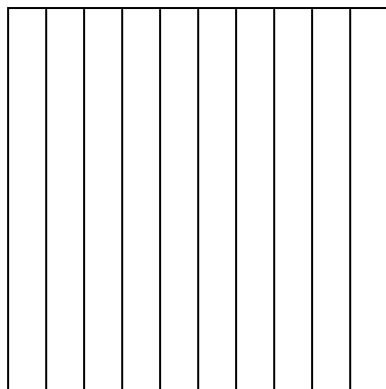
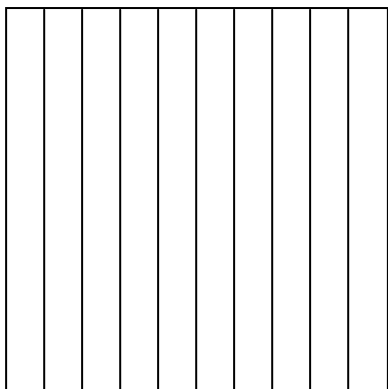
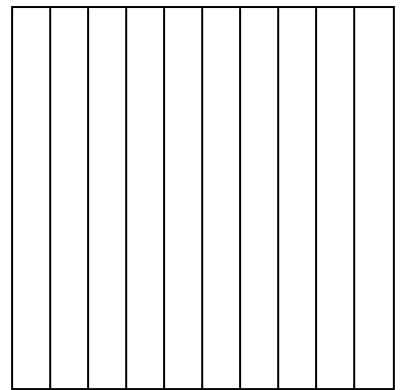
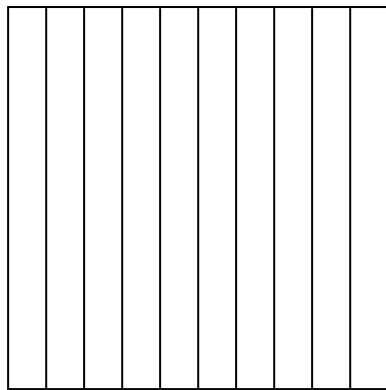
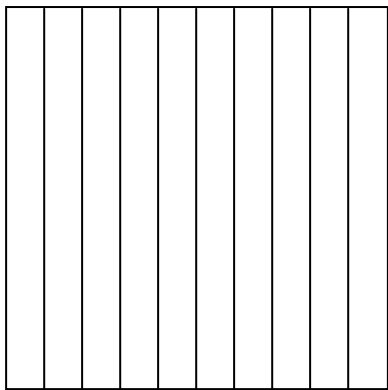
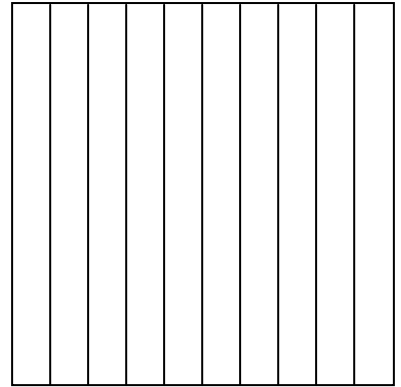
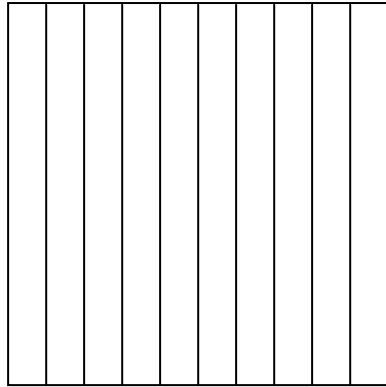
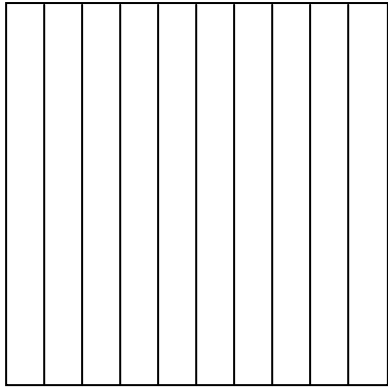

Decimal Squares (hundredths)

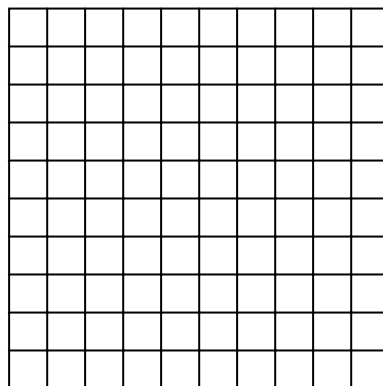
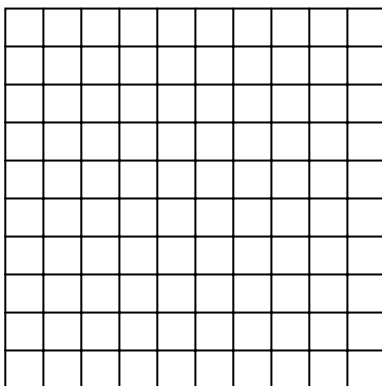
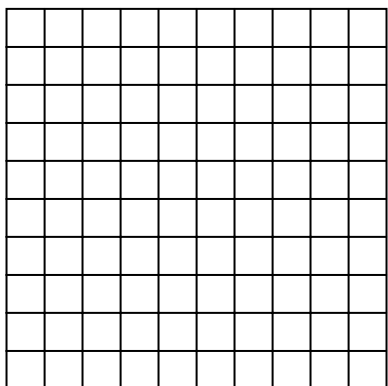
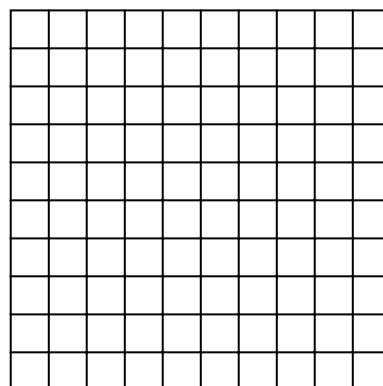
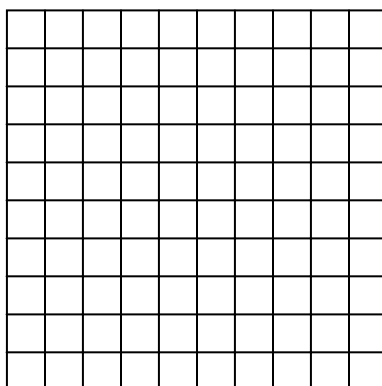
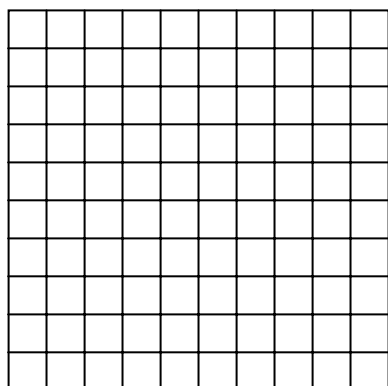
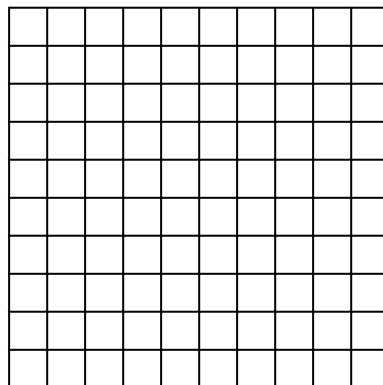
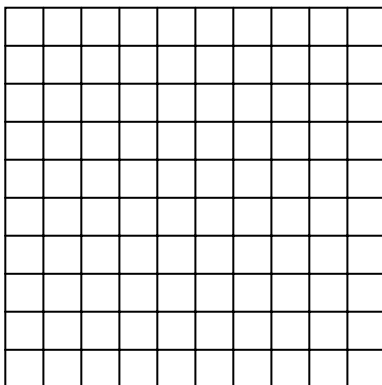
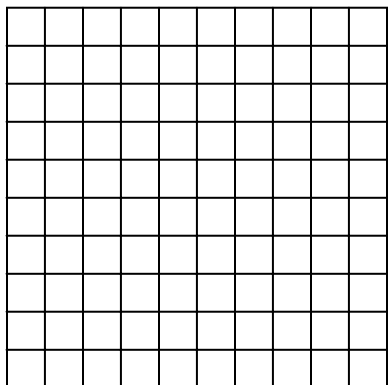
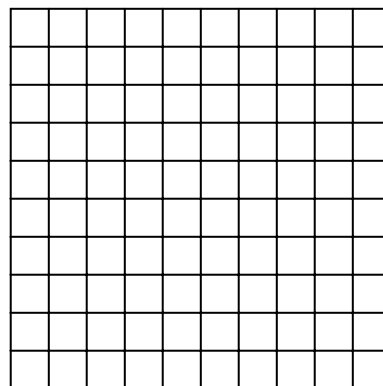
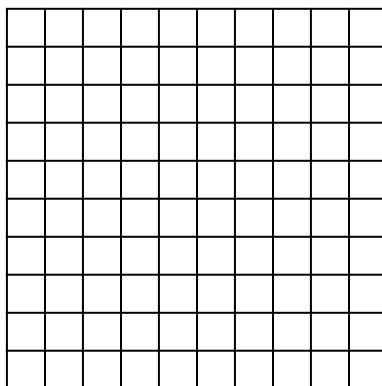
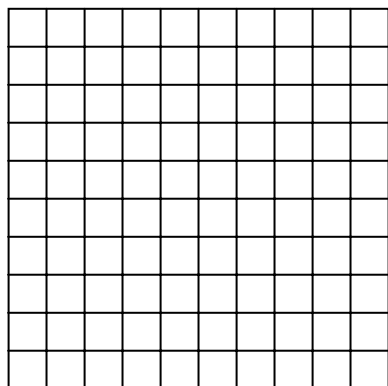

Decimal Squares (thousandths)

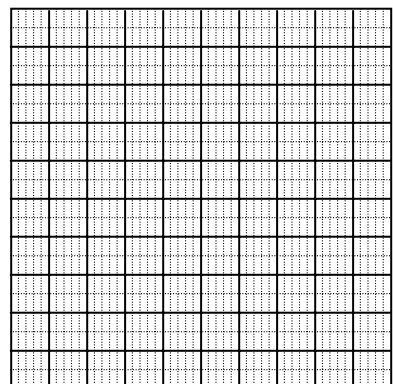
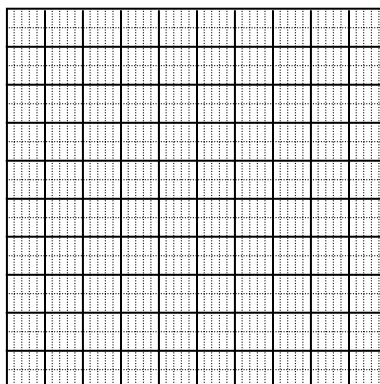
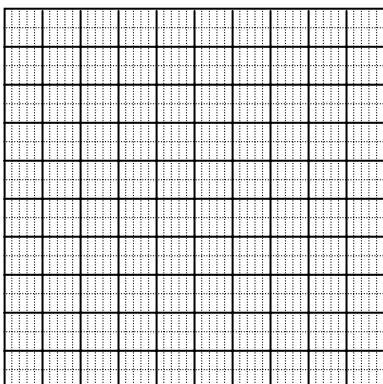
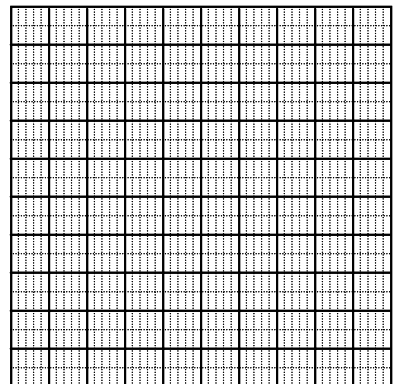
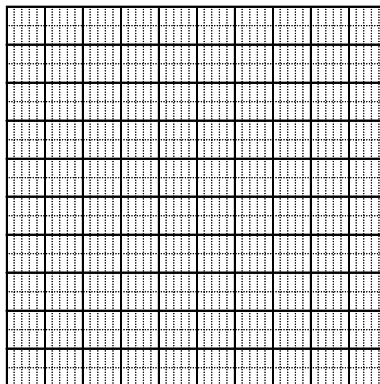
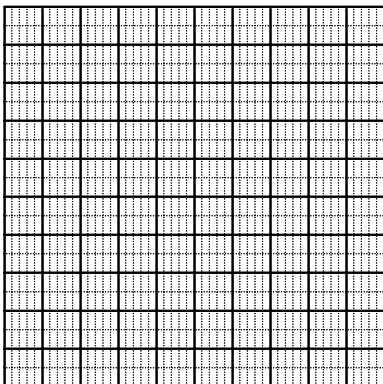
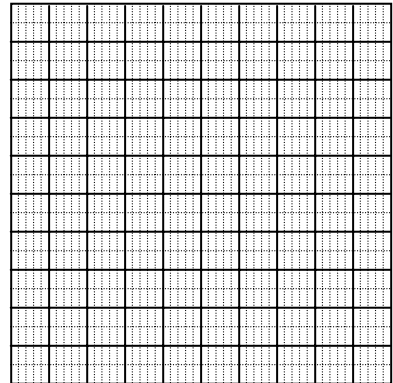
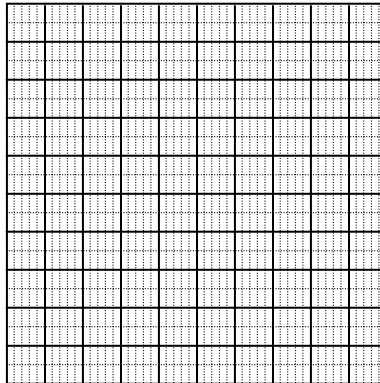
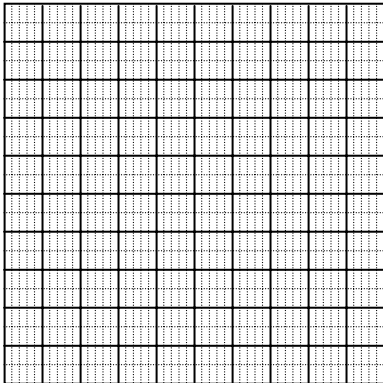
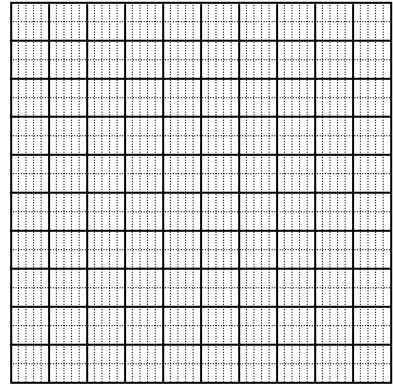
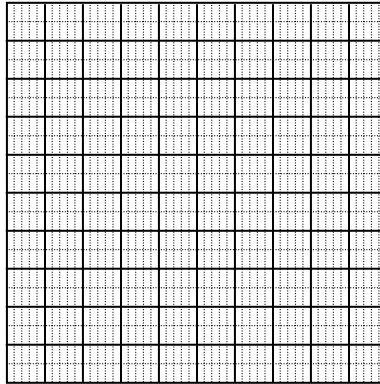
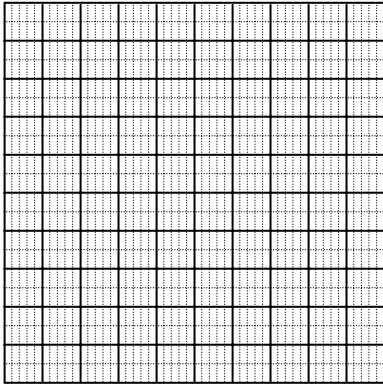

Isometric Dot Paper (1 cm)

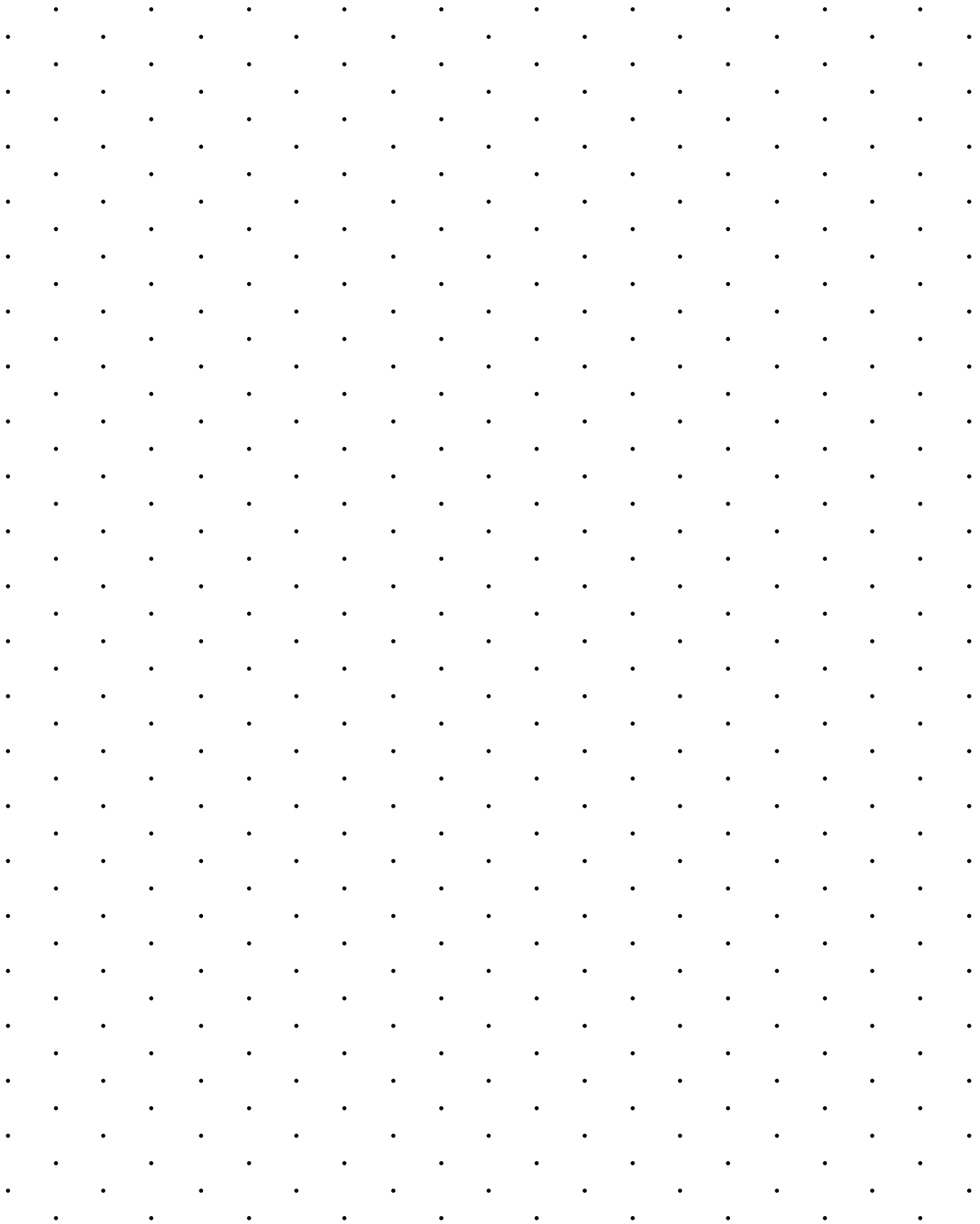

Isometric Dot Paper (2 cm)

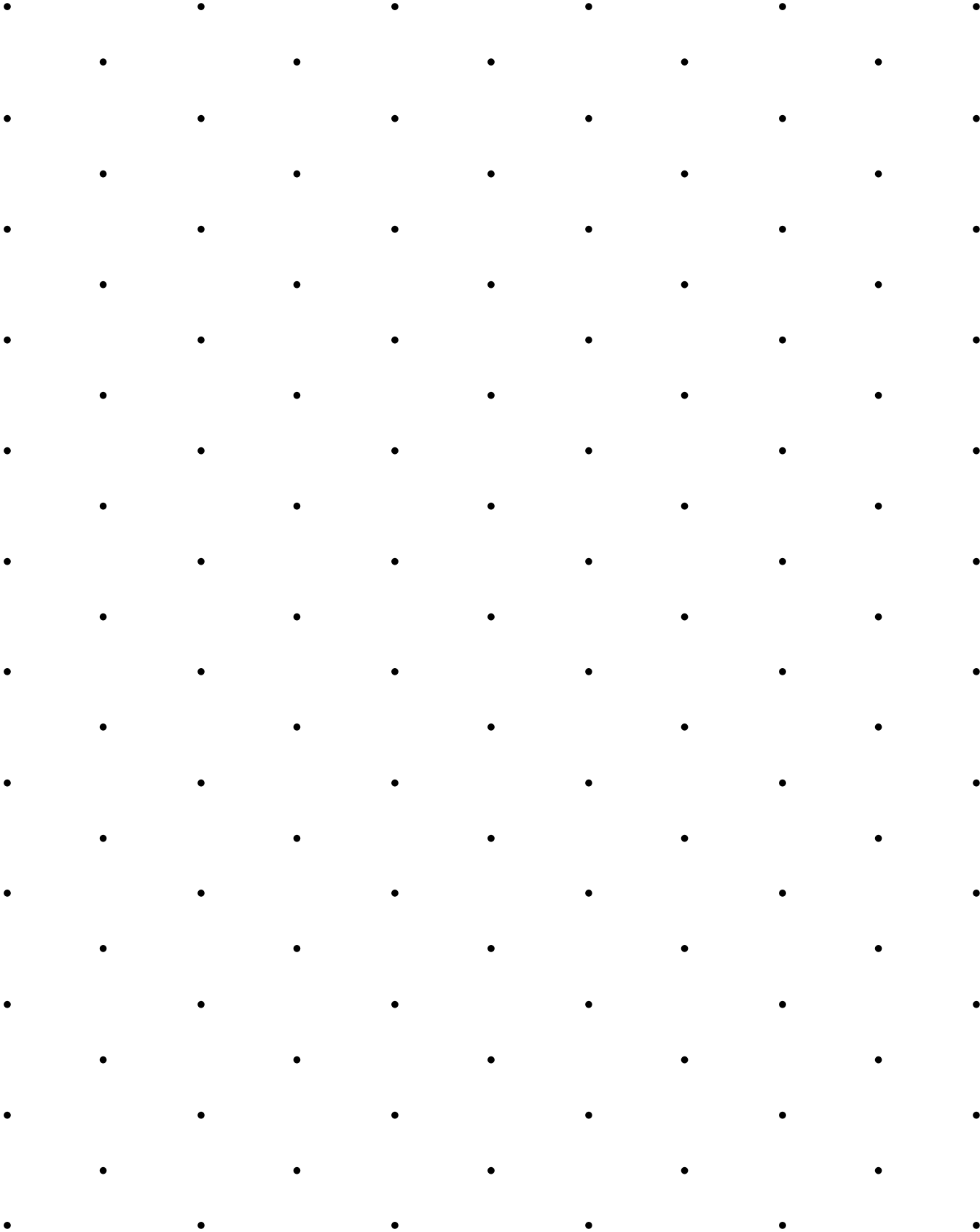

Square Dot Paper (0.5 cm)

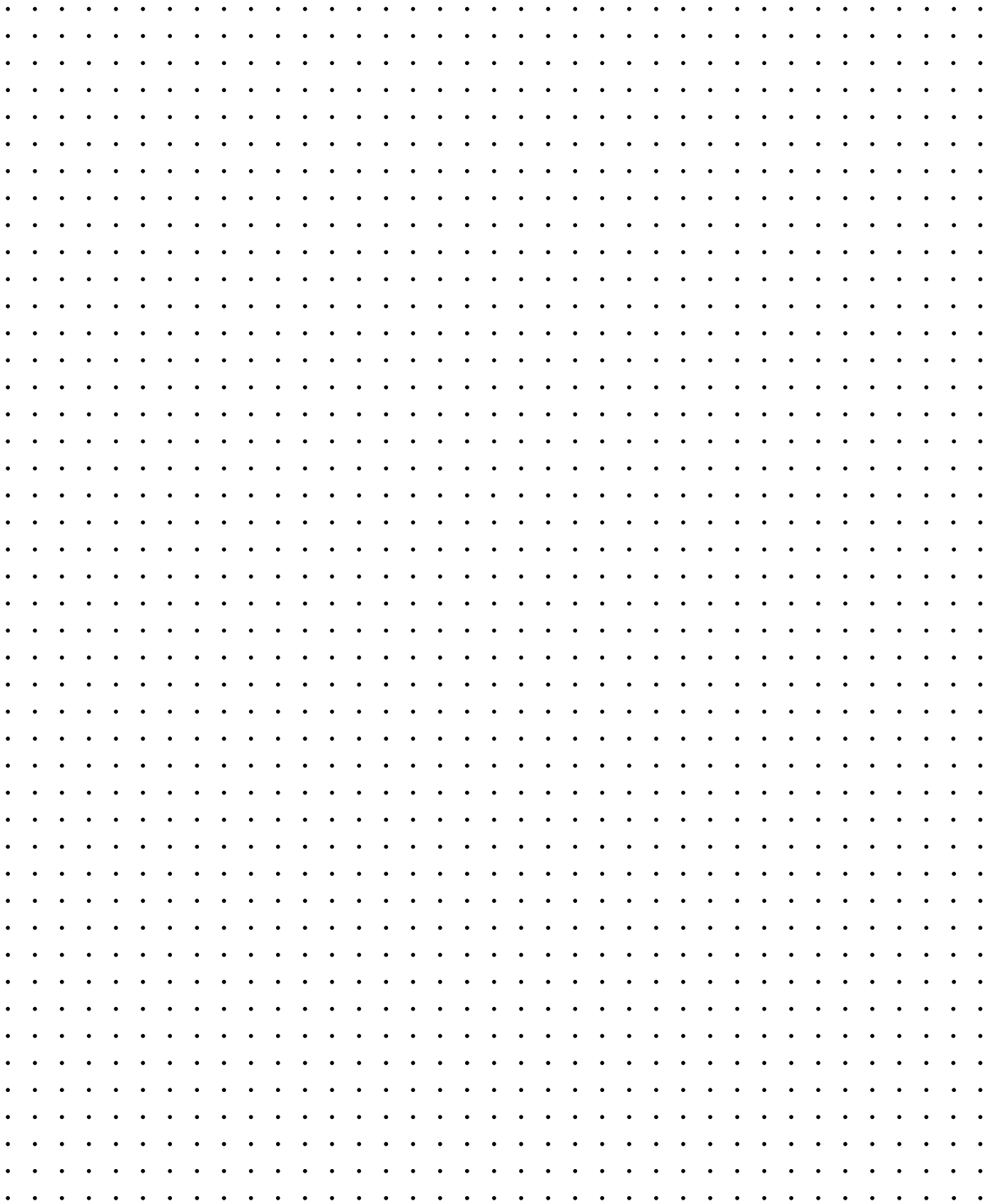

Square Dot Paper (1 cm)

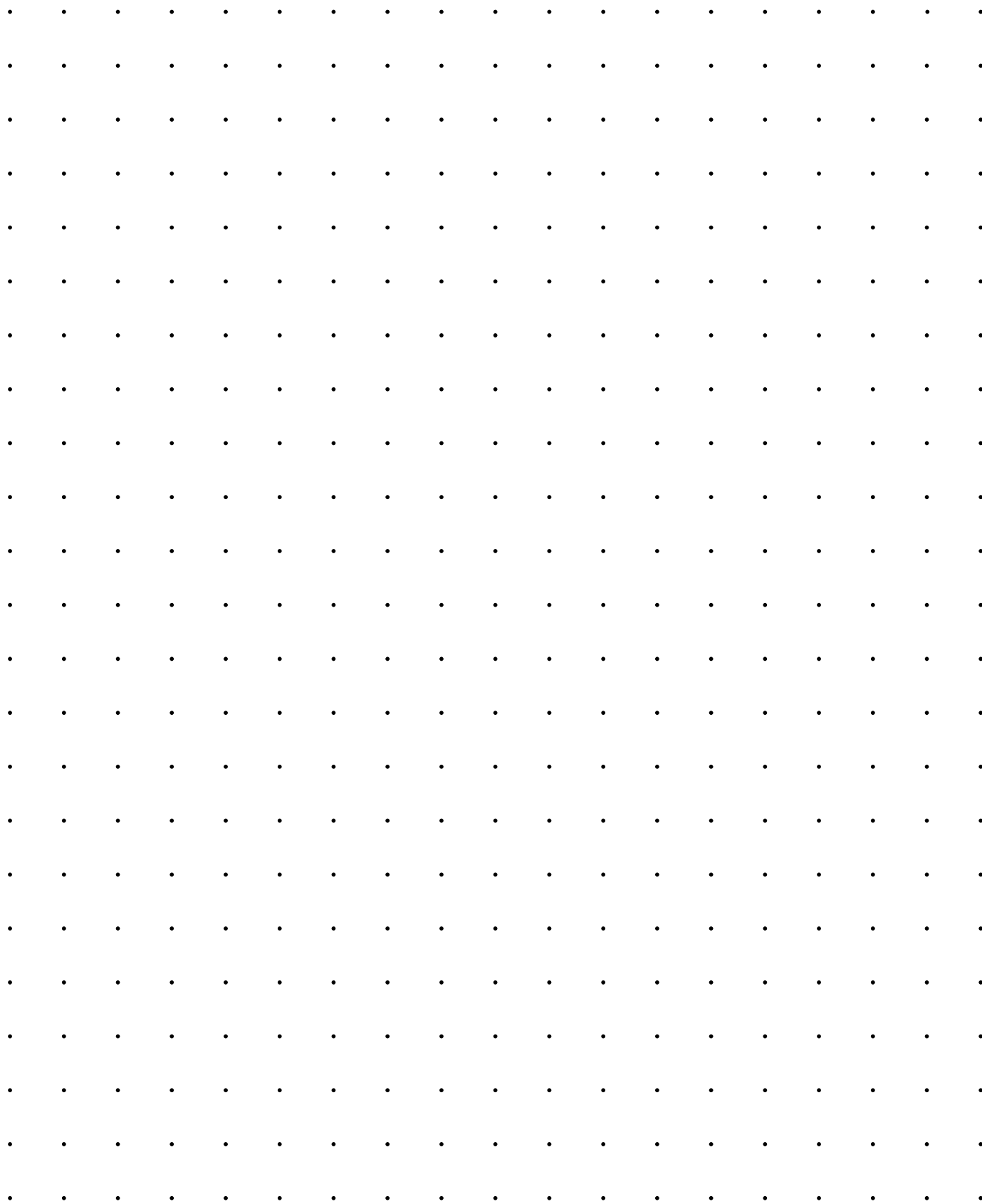

Square Dot Paper (2 cm)



Triangle Dot Paper

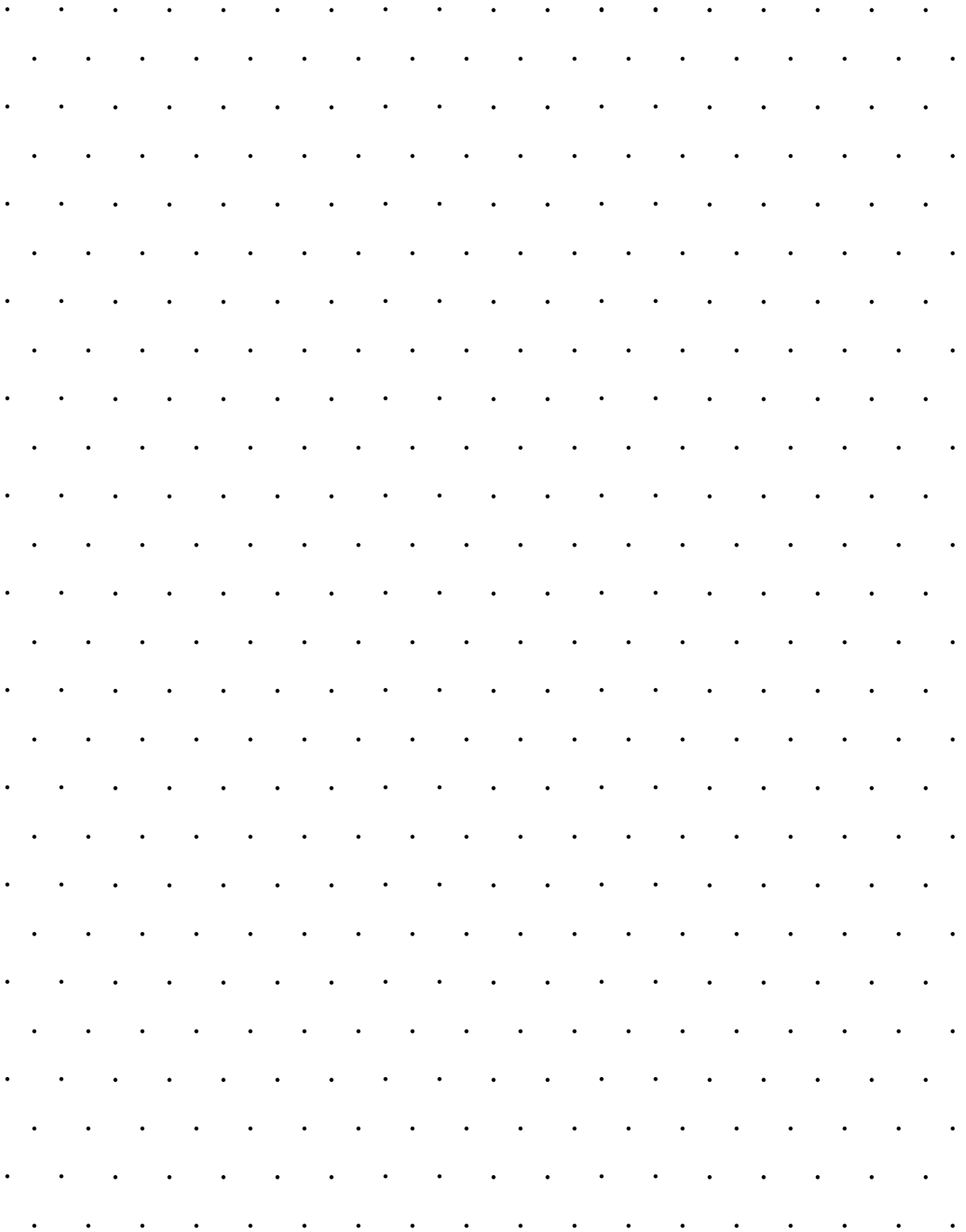

Fraction Circles (to sixteenths labelled)

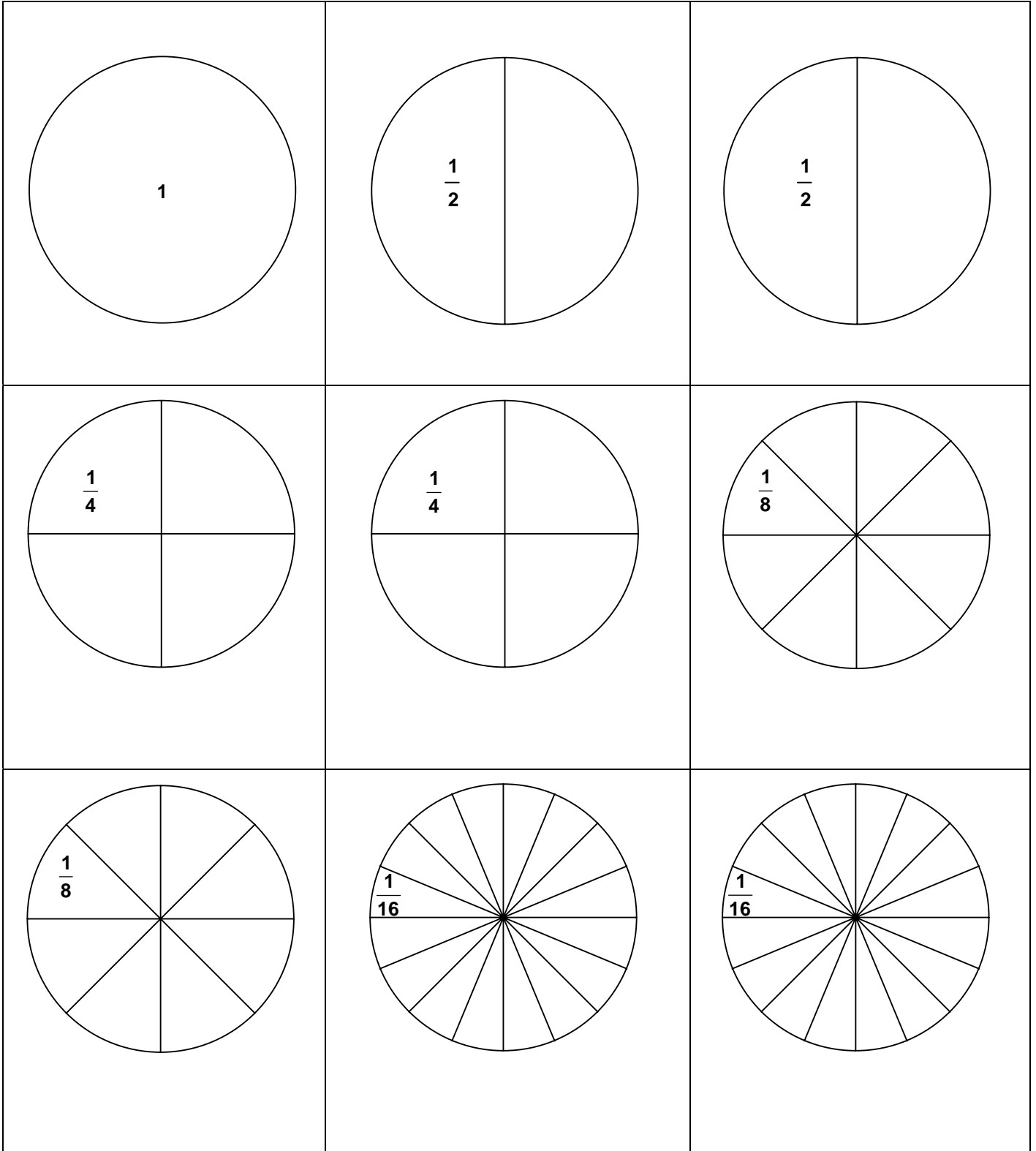

Fraction Circles (to sixteenths unlabelled)

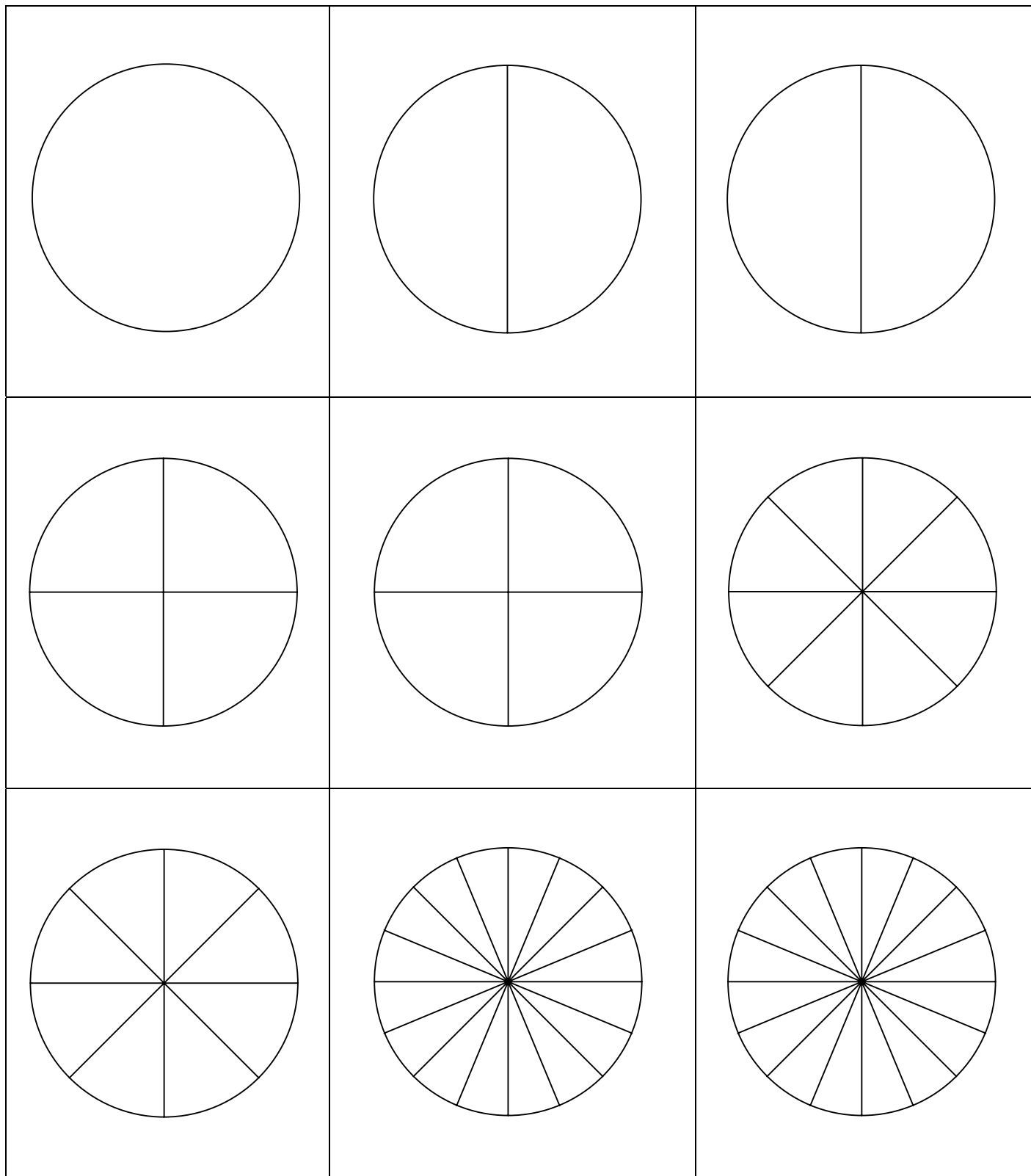

Fraction Strips (to sixteenths labelled)

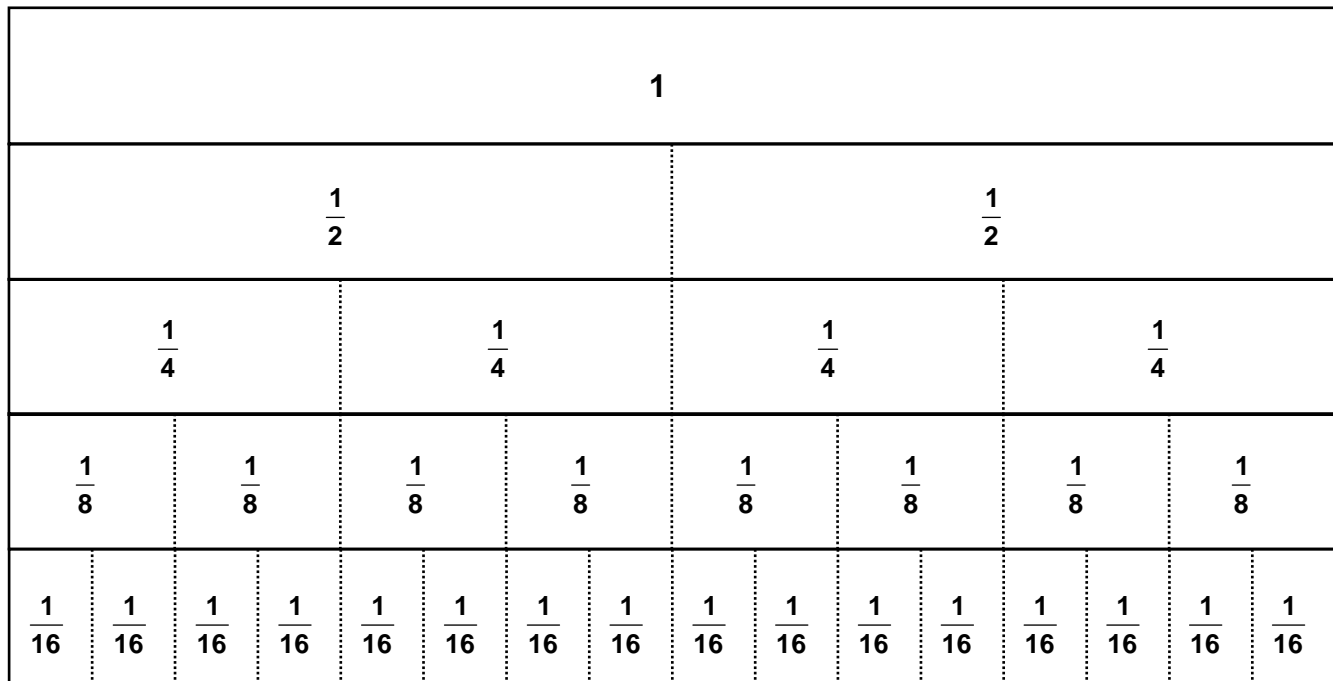
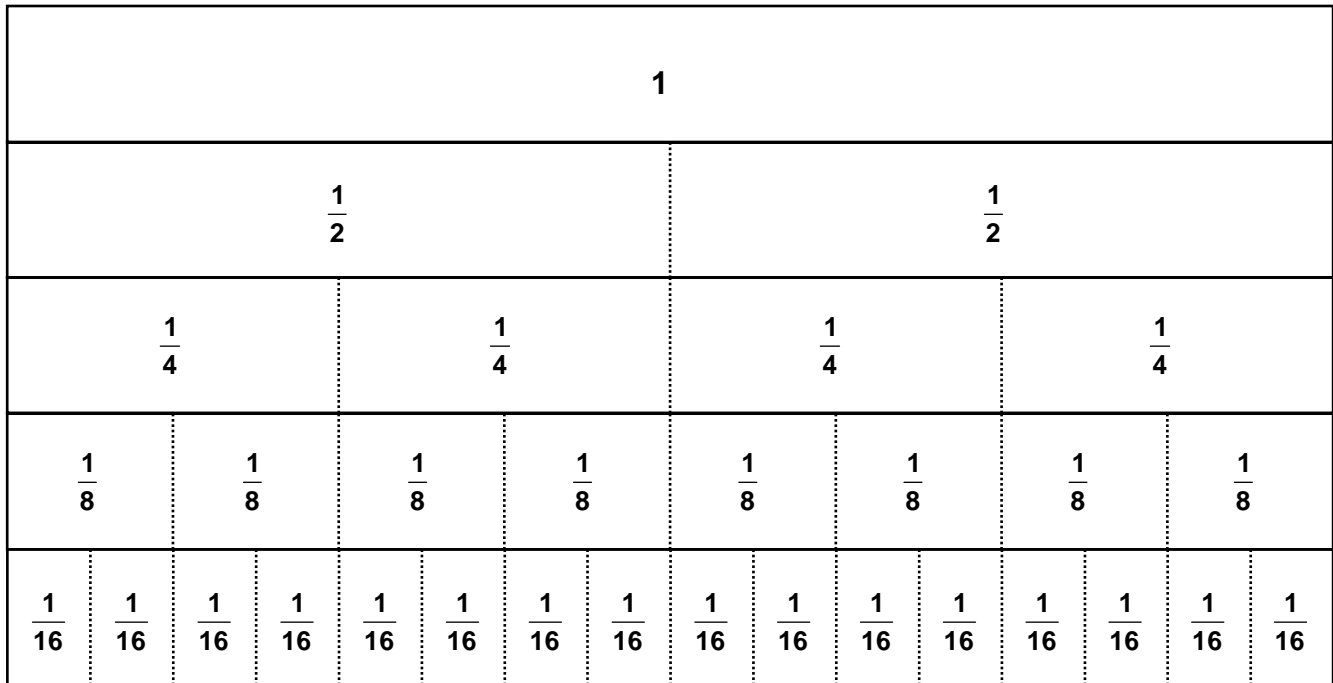

Fraction Strips (to sixteenths unlabelled)

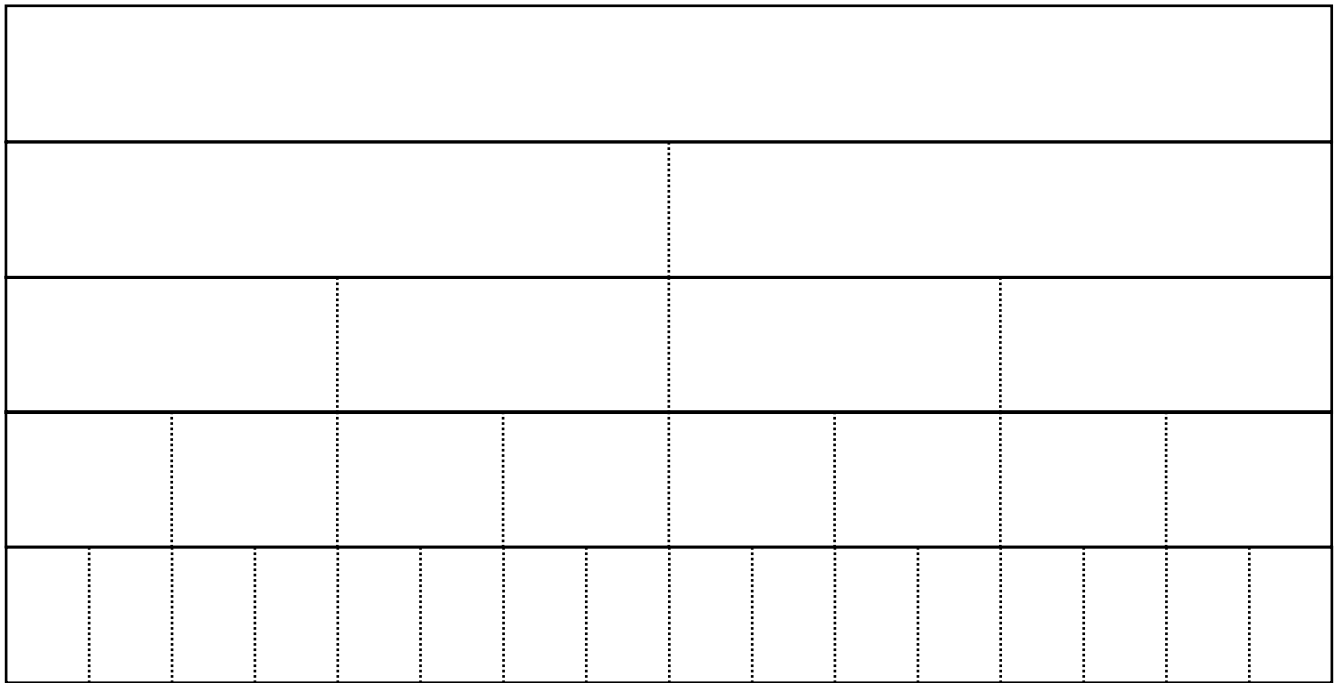
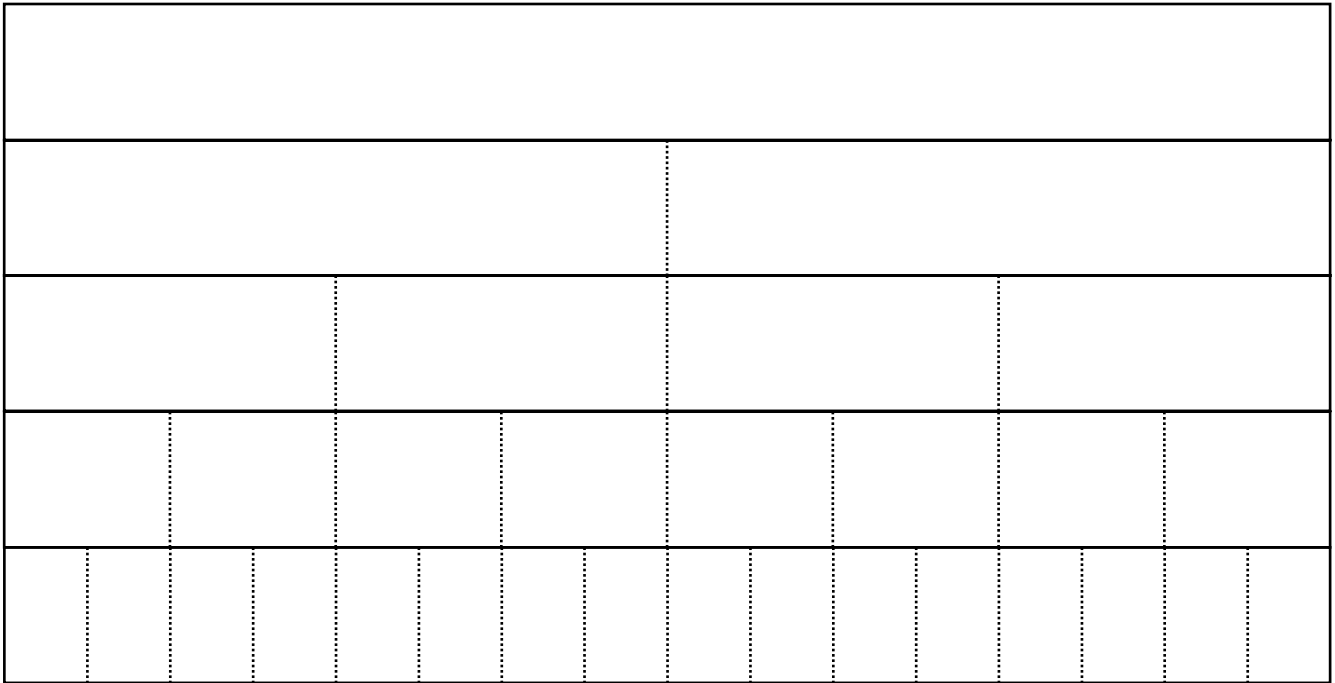

Pythagorean Theorem

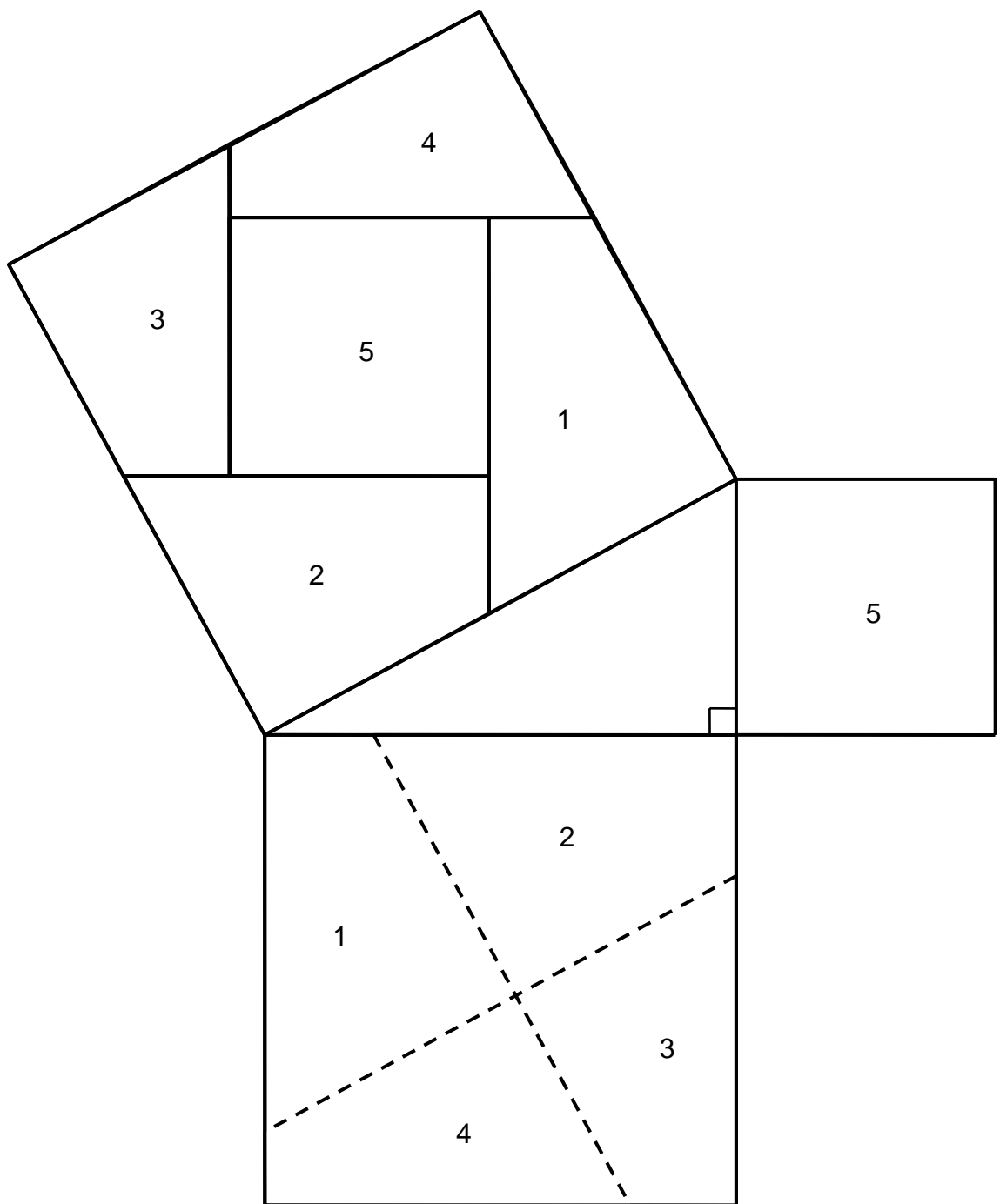

Isometric Drawings 1

Make this structure with your cubes then draw three different views of the structure below.

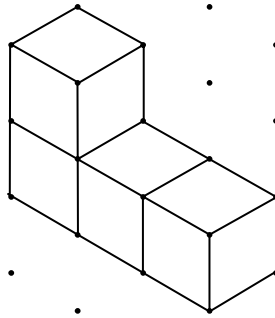

Isometric Drawings 2

Make this structure with your cubes then draw three different views of the structure below.

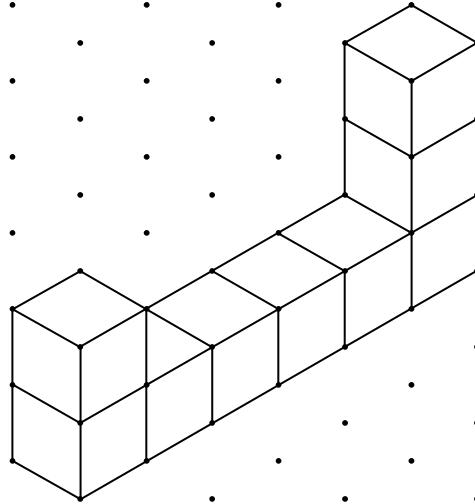

Net (closed cylinder)

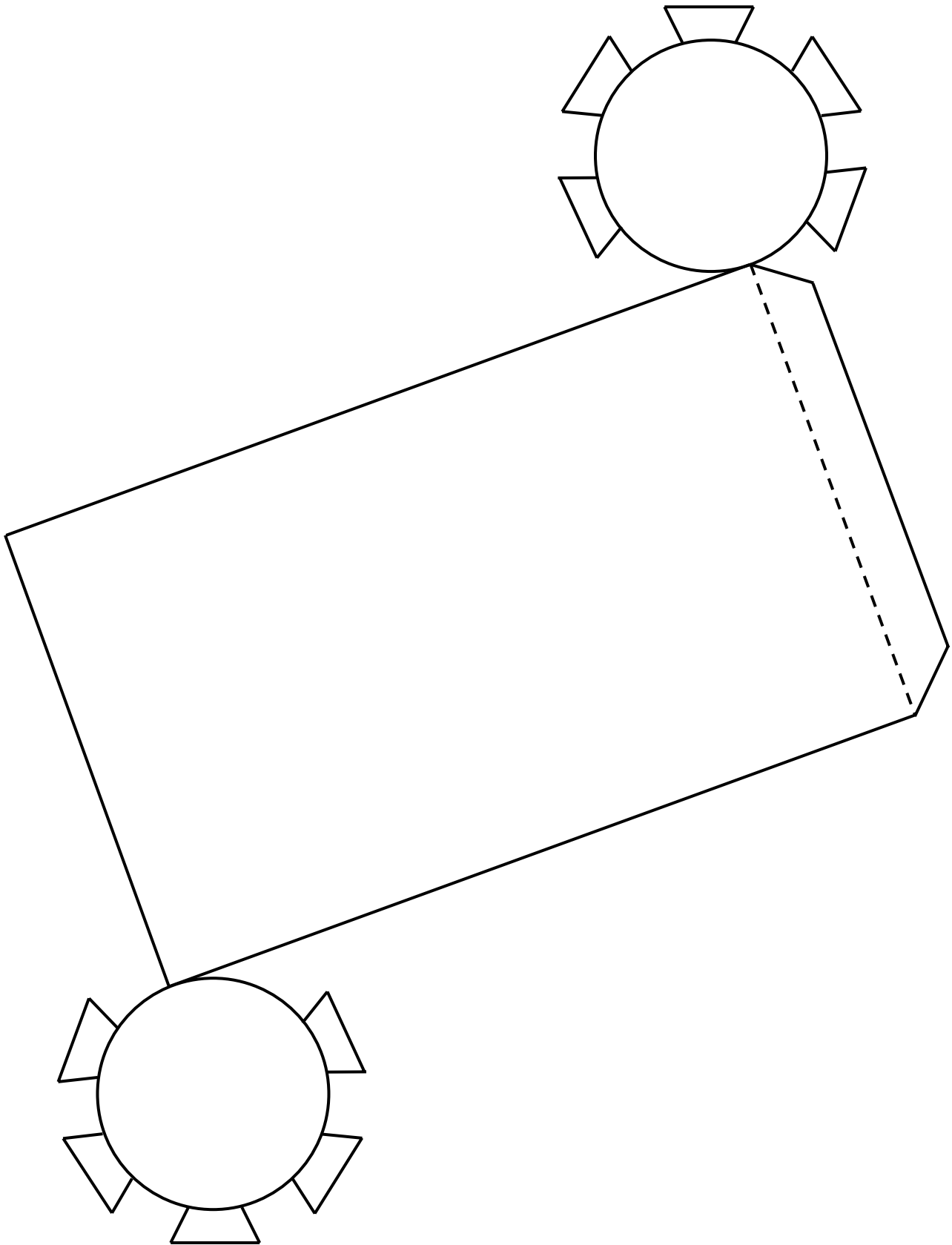

Net (open cylinder)

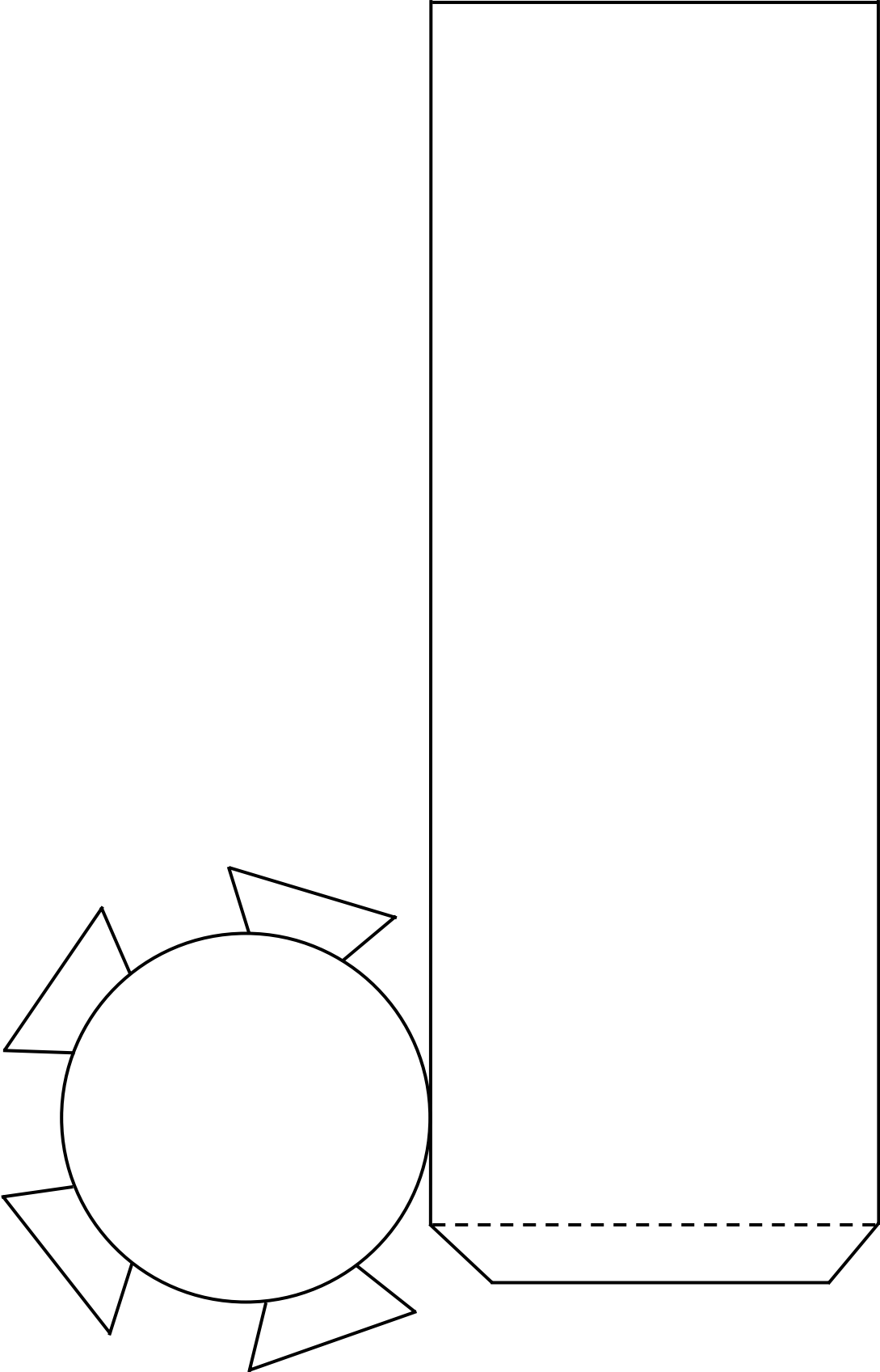

Net (rectangular prism)

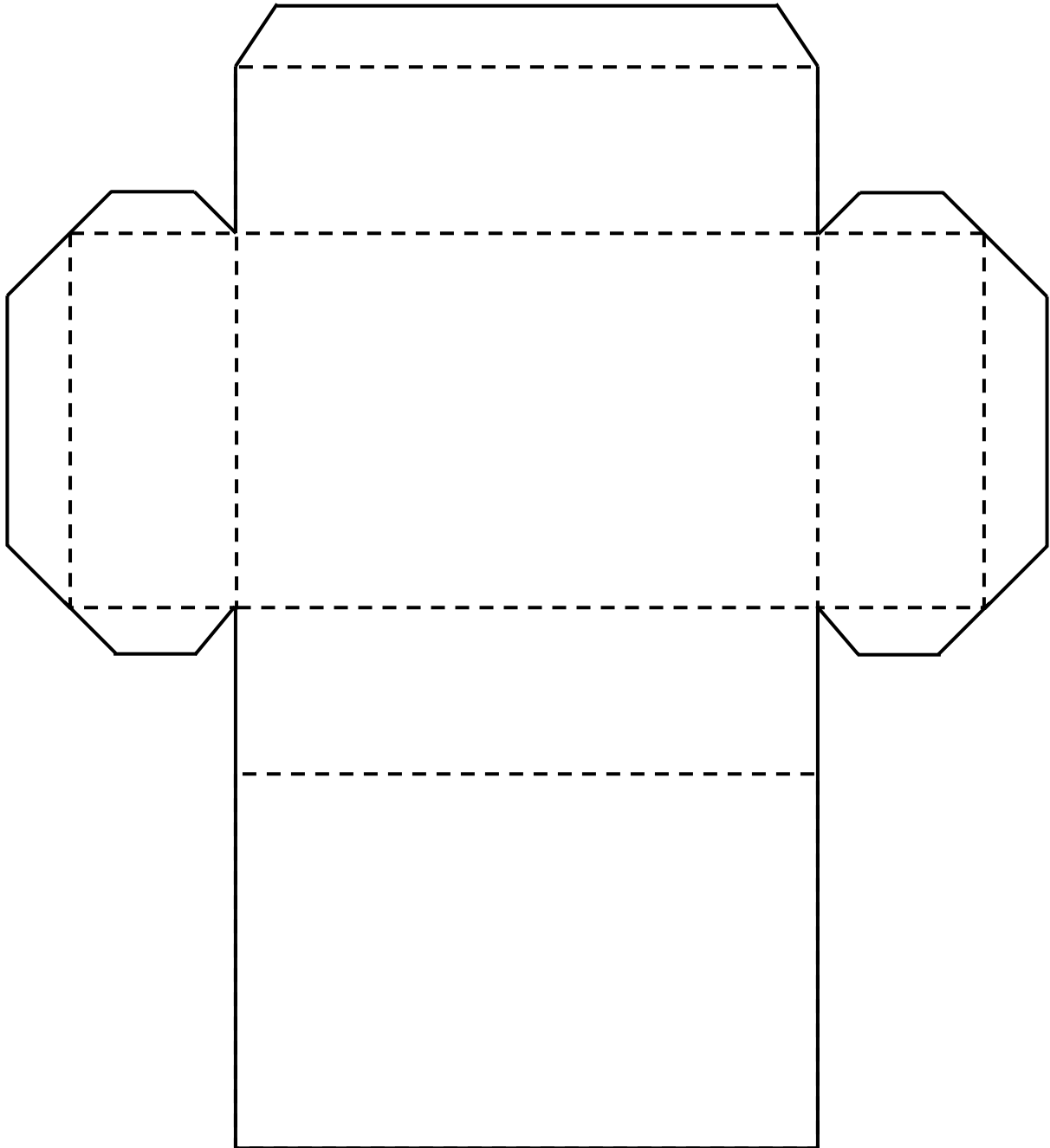

3-D Skeletons

Cube

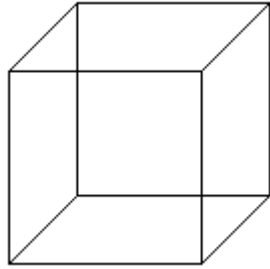

Square prism

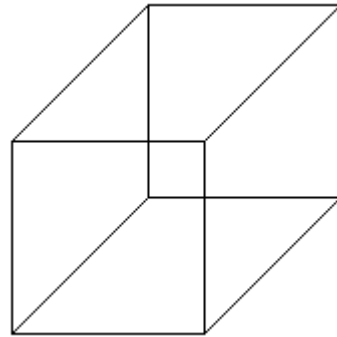

Rectangular prism

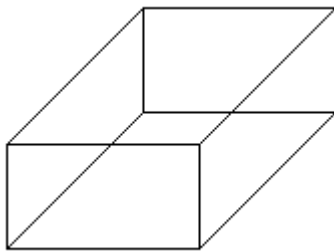

Right triangular prism

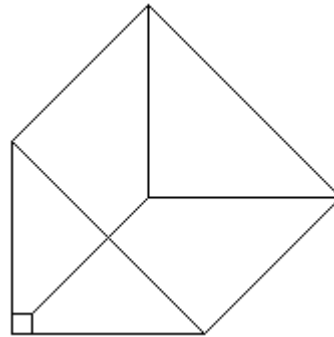

Trapezoidal prism

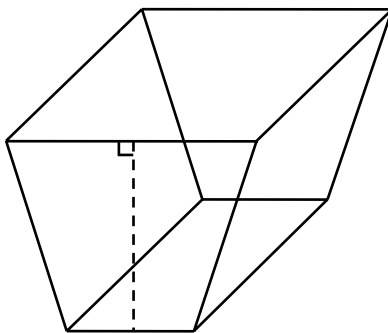

Isosceles triangular prism

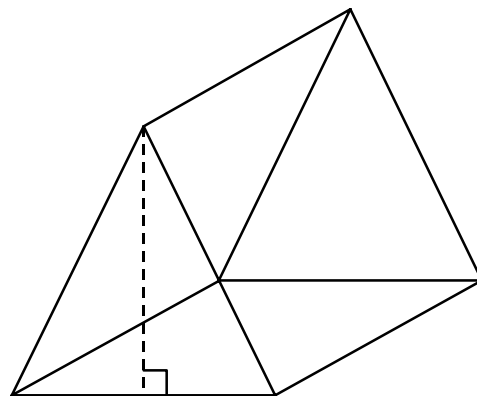

Cylinder 1

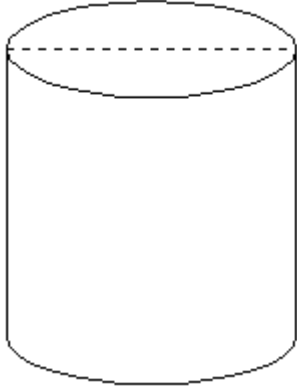

Cylinder 2

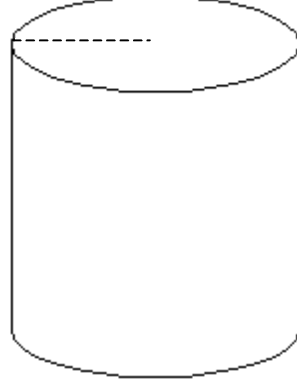

Cone

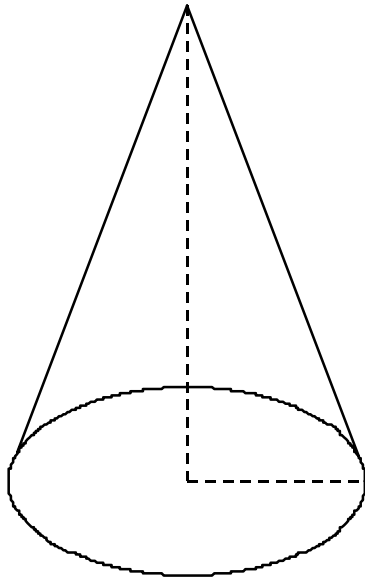

Tetrahedron

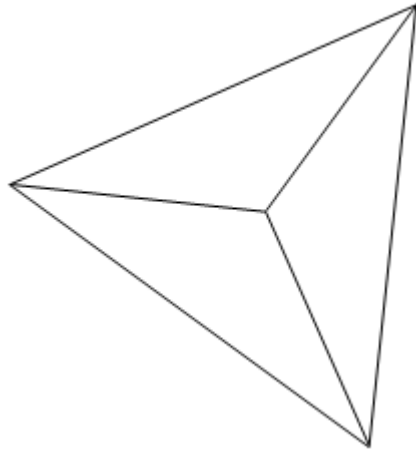

Grids (10 X 10)

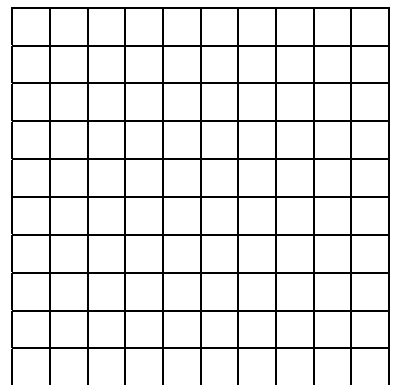
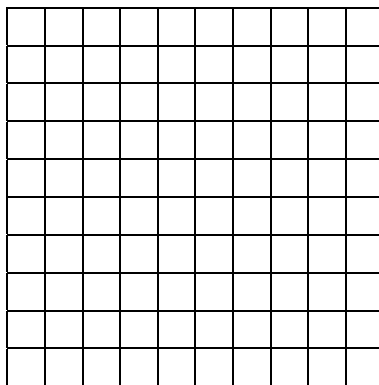
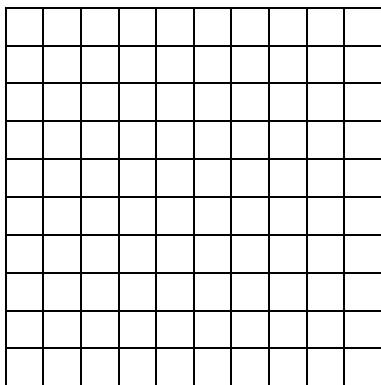
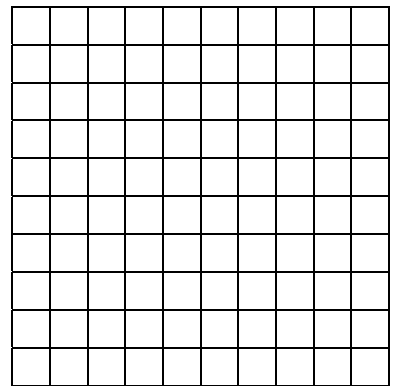
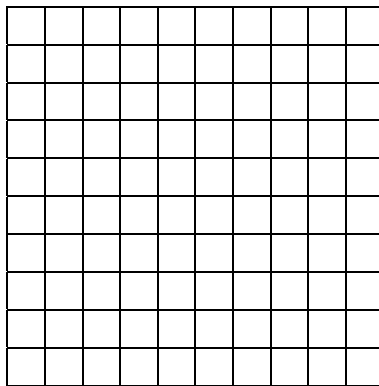
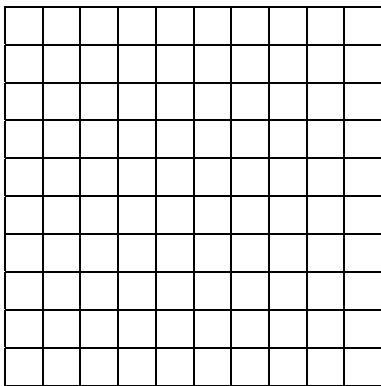
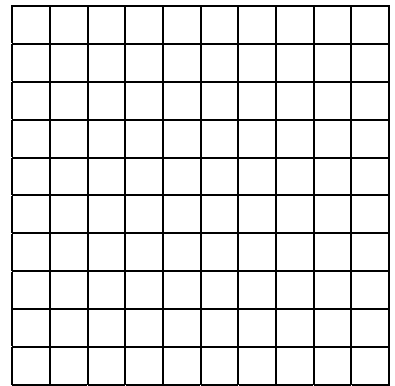
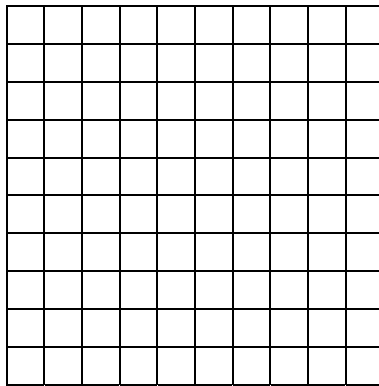
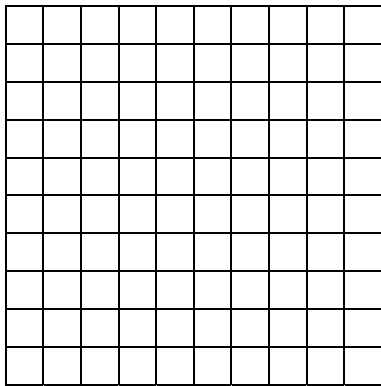
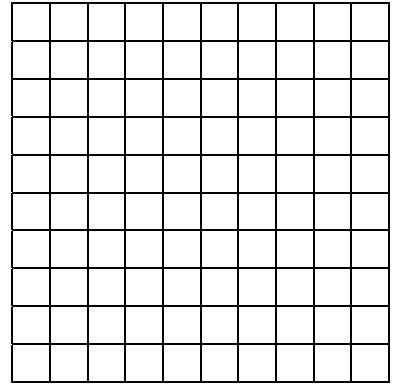
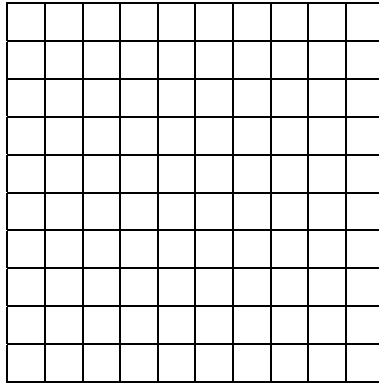
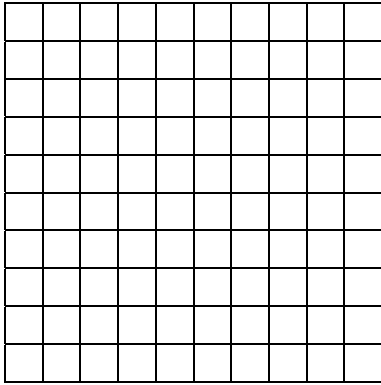

Grid Paper (0.5 cm)

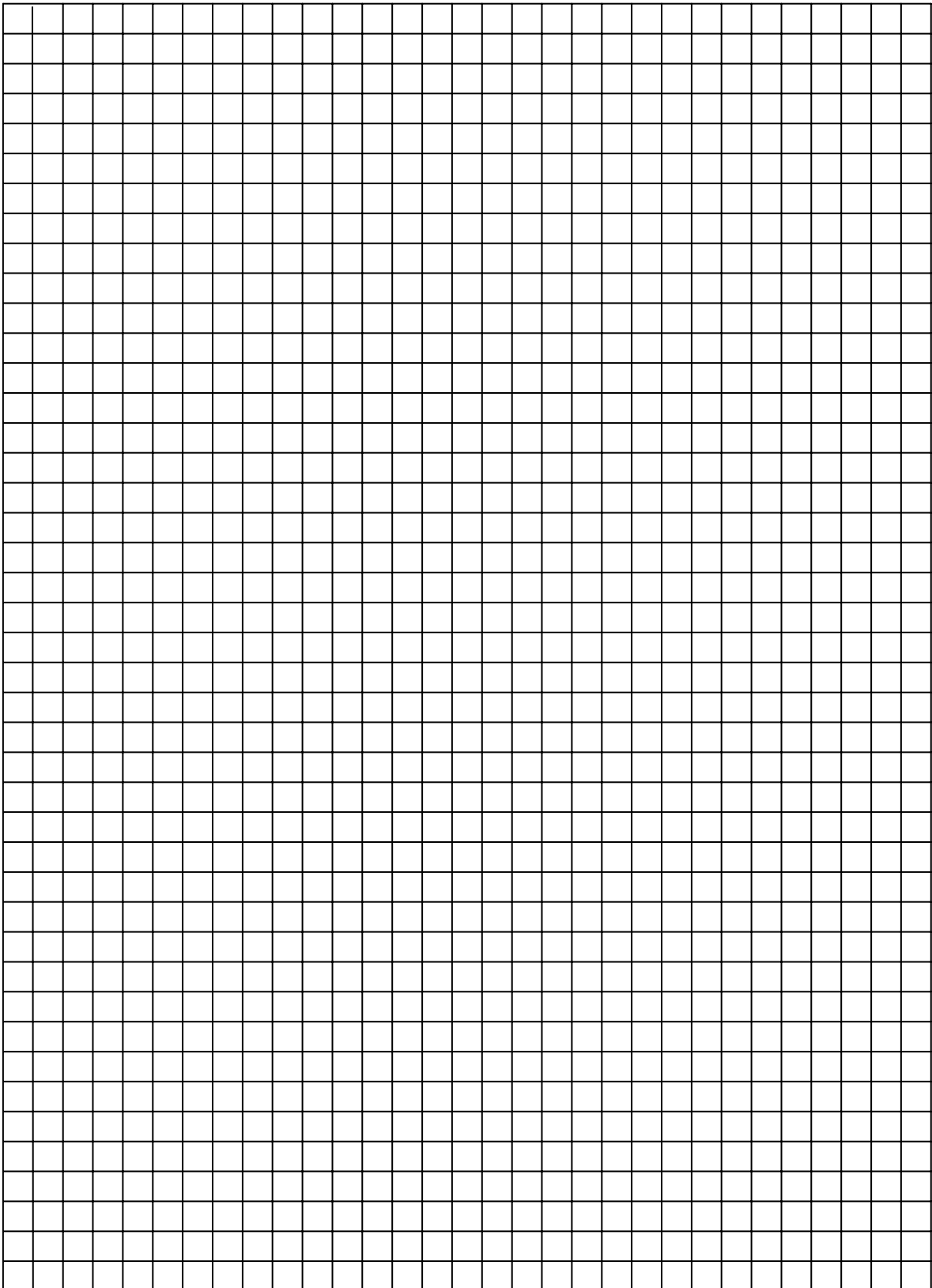

Grid Paper (1.0 cm)

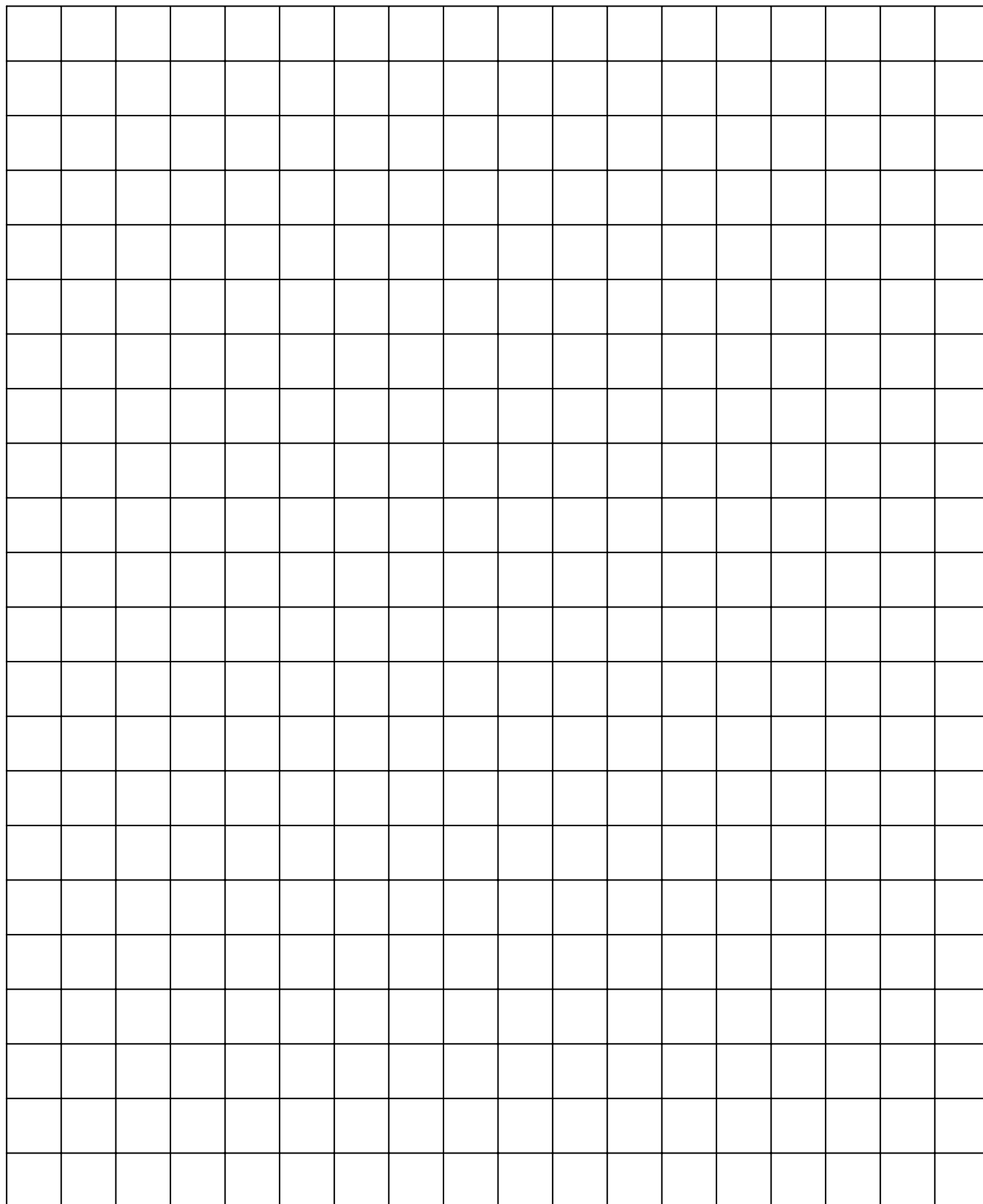

Grid Paper (2.0 cm)

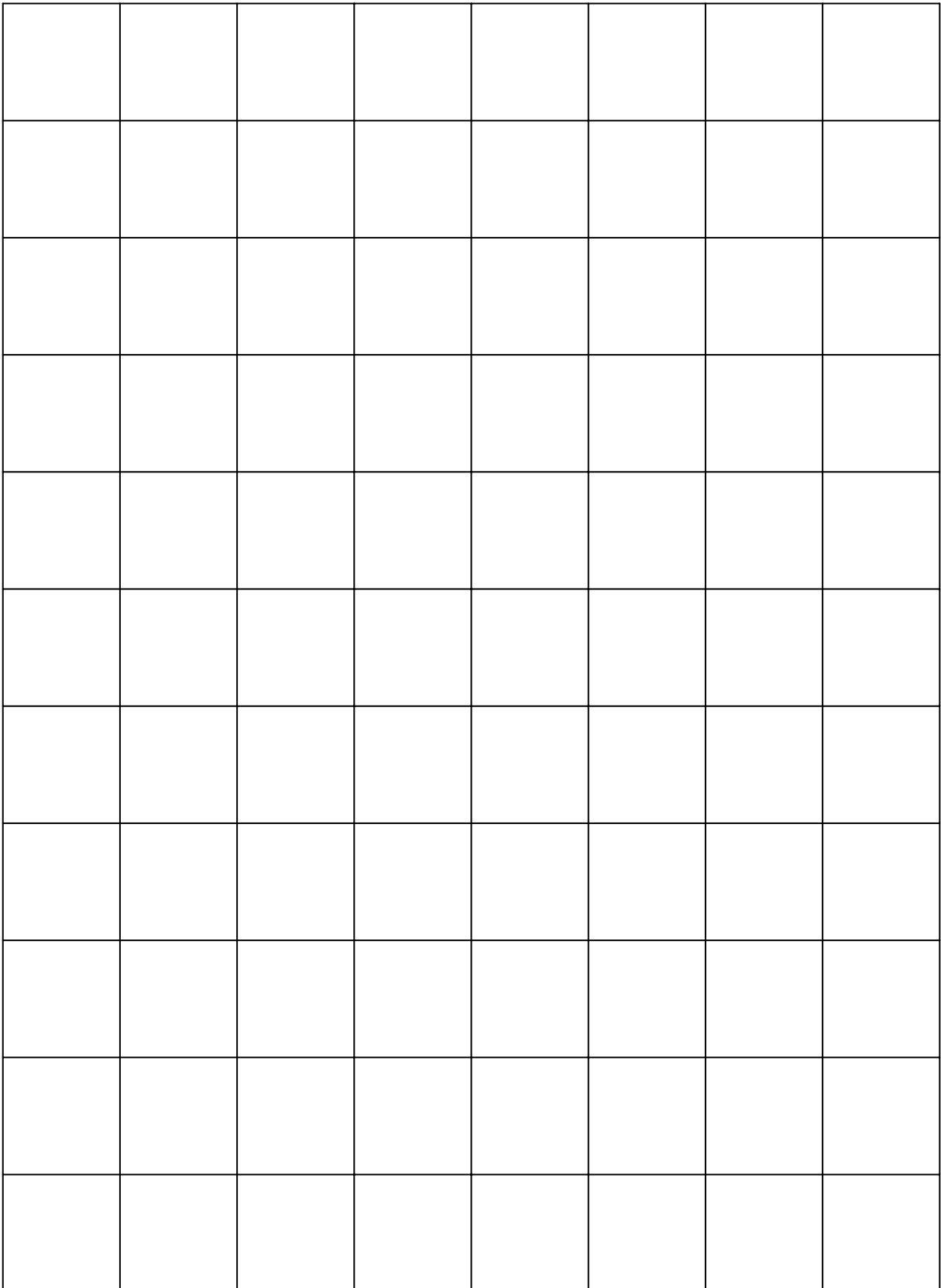

Ten Thousands Grid

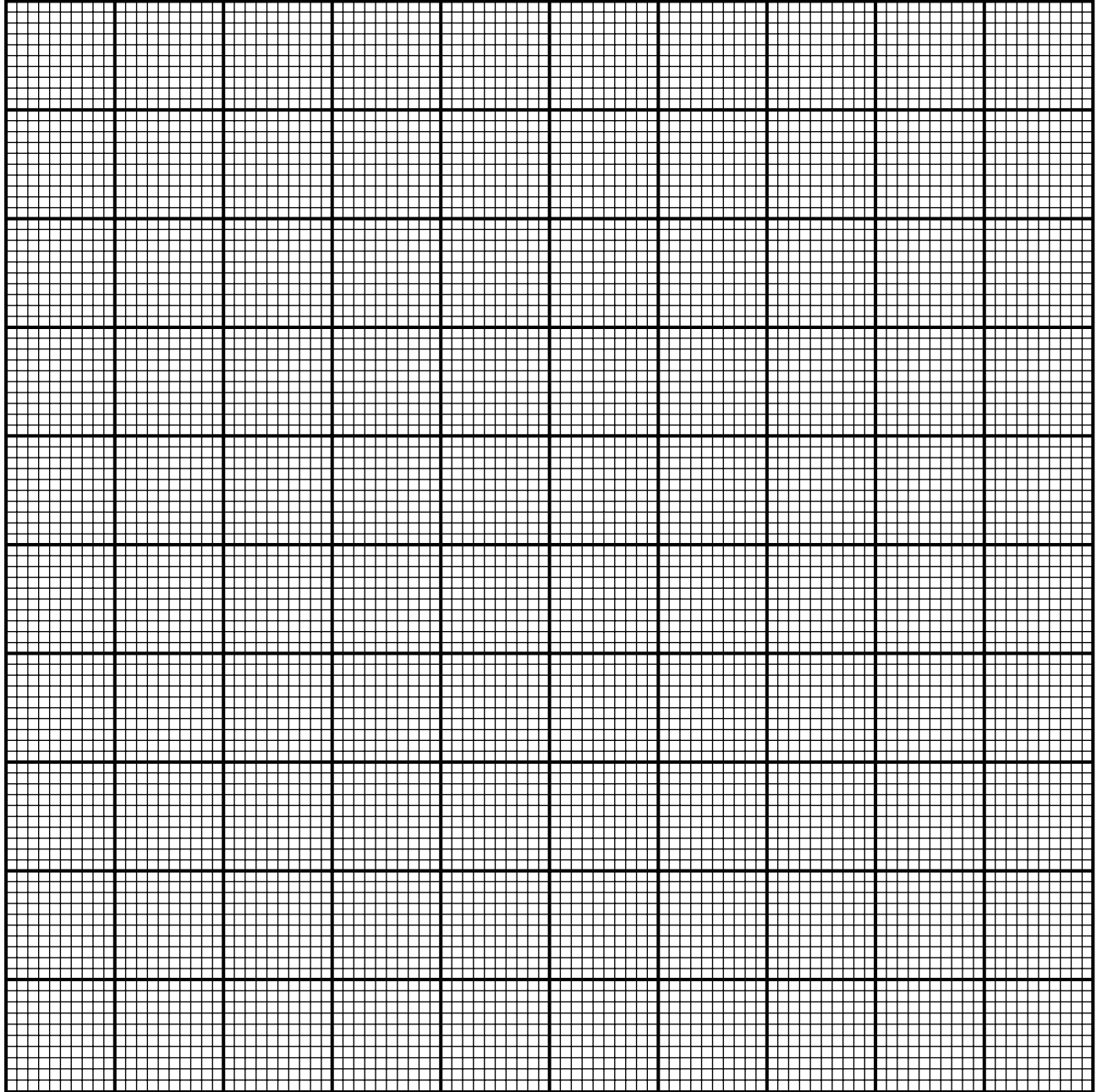

Thermometers 1

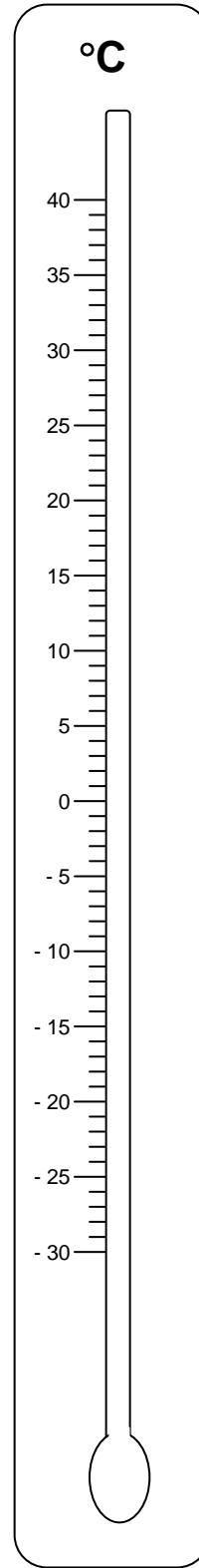
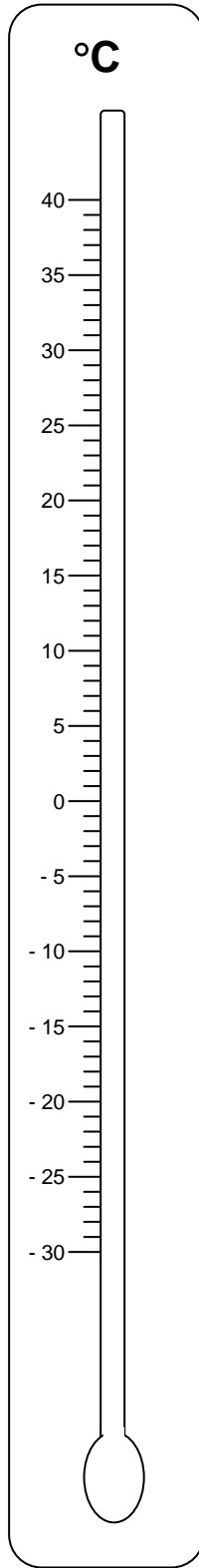
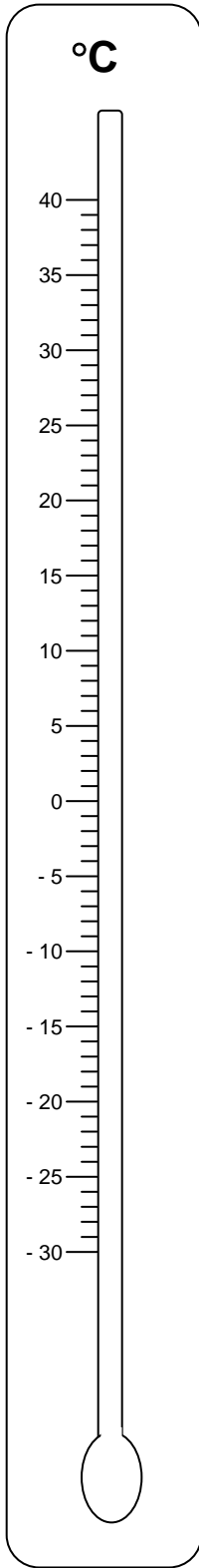

Thermometers 2

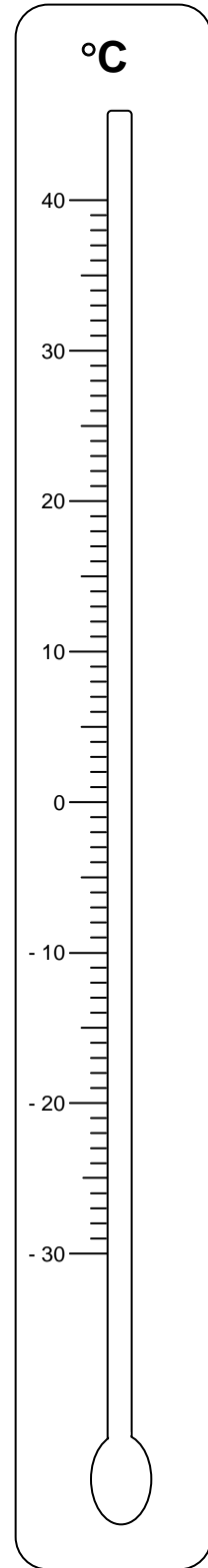
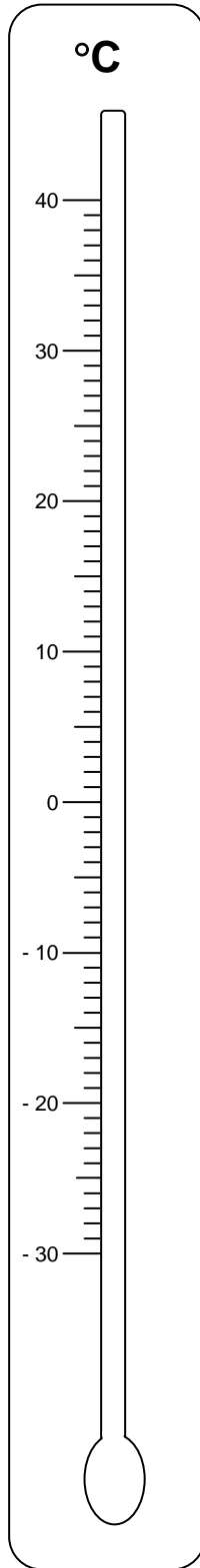
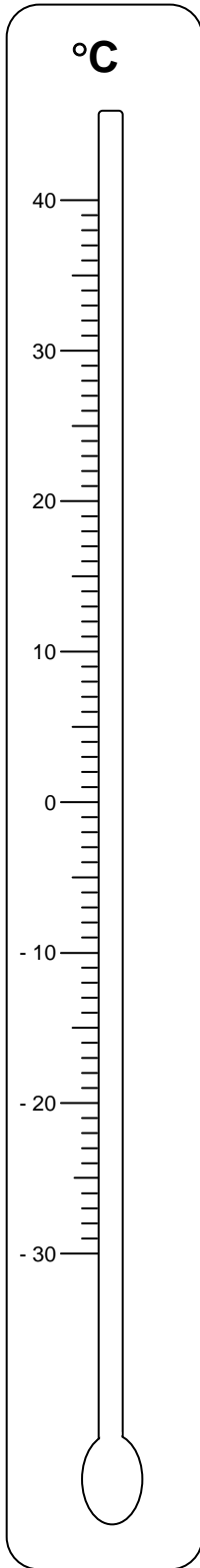

Thermometers 3

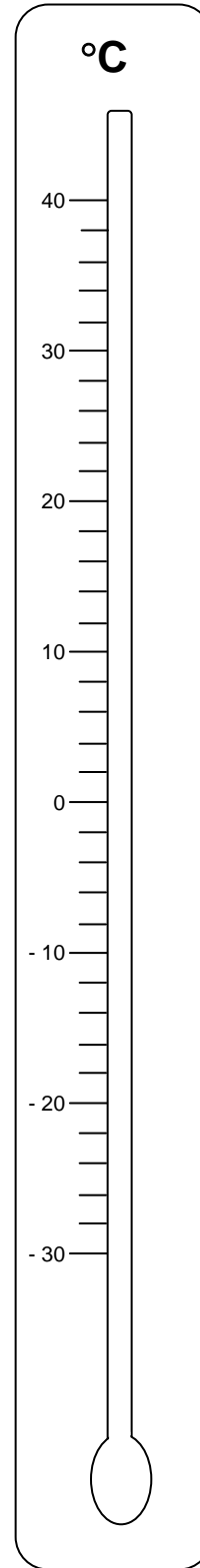
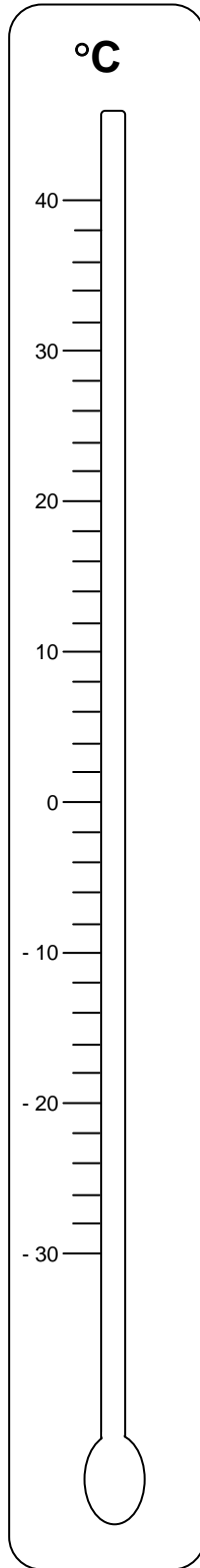
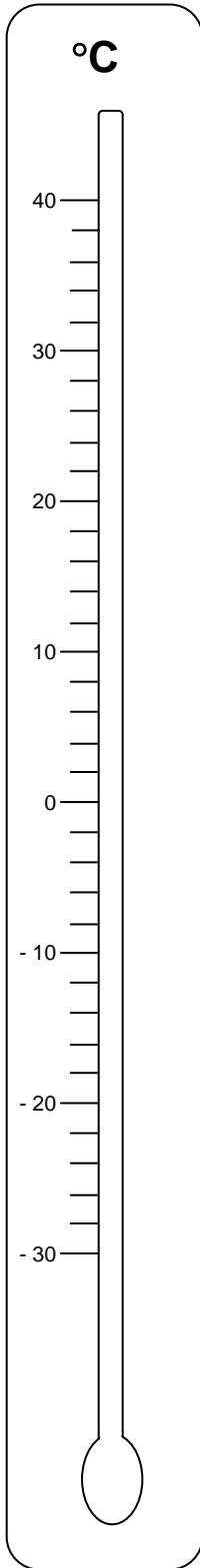

Number Strips (100 cm)

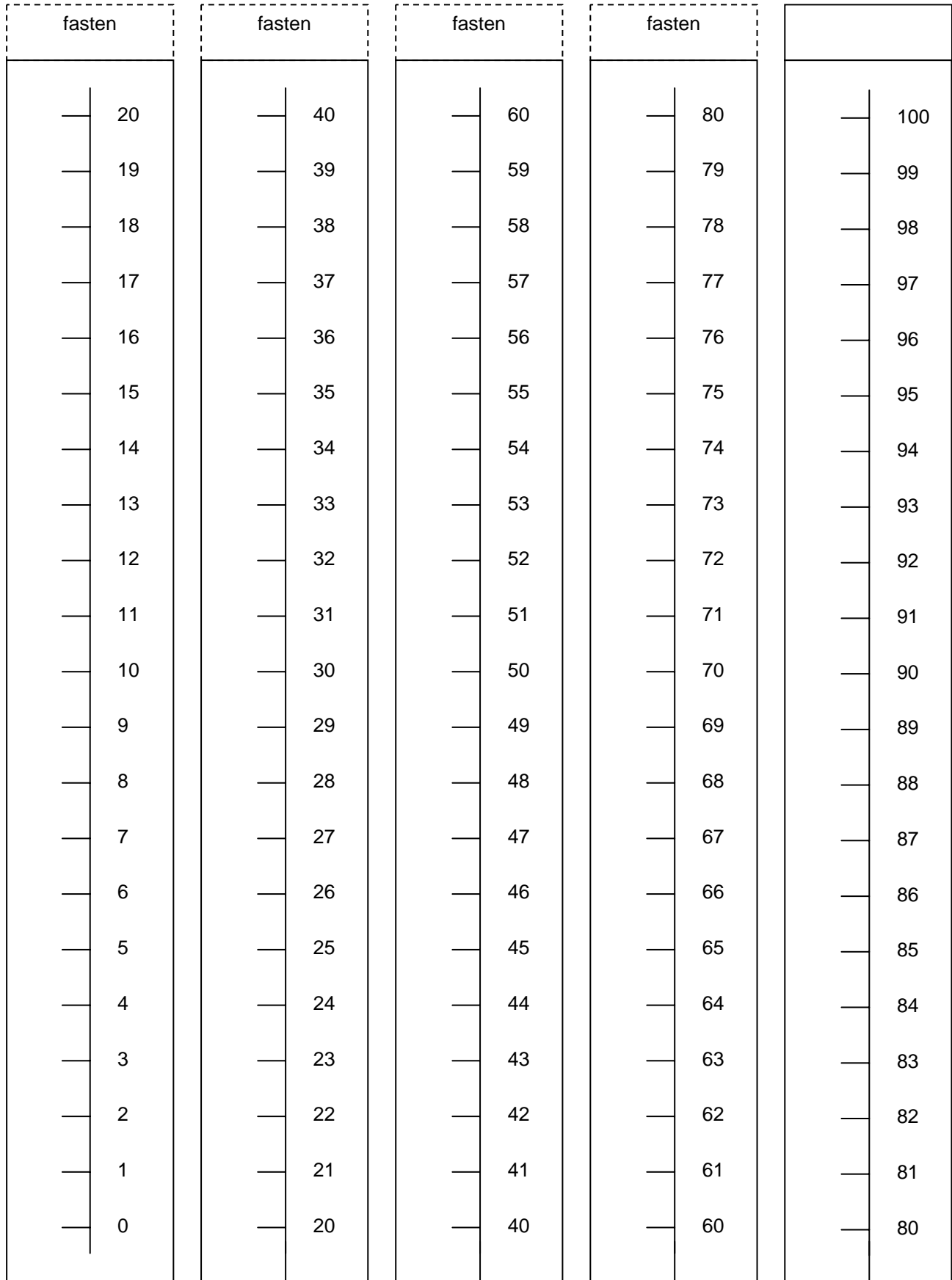

Measurement Recording Sheet

The object I measured	This is what I used to measure	This is my estimate	This is the actual measure

Protractors

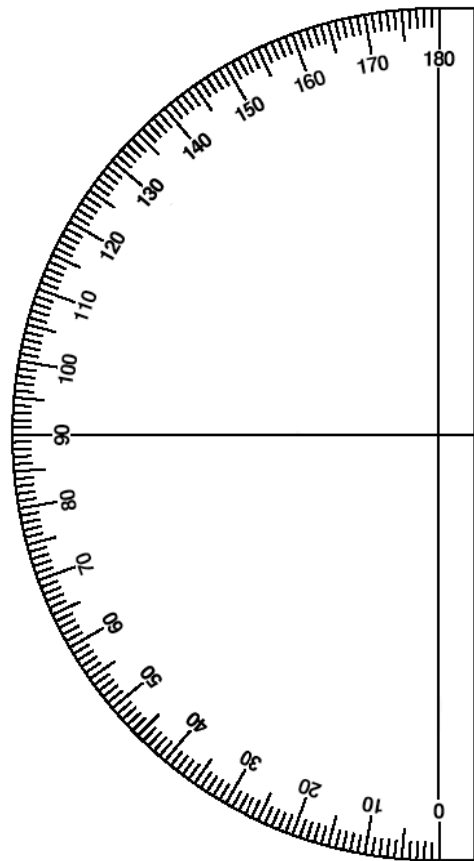
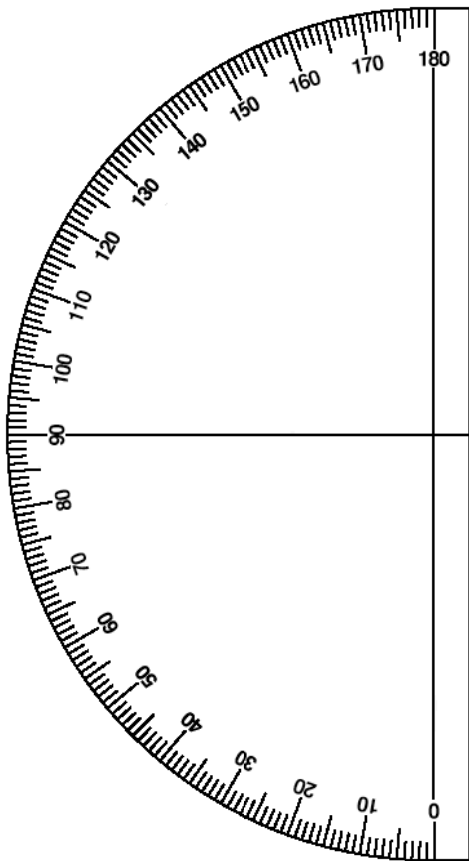
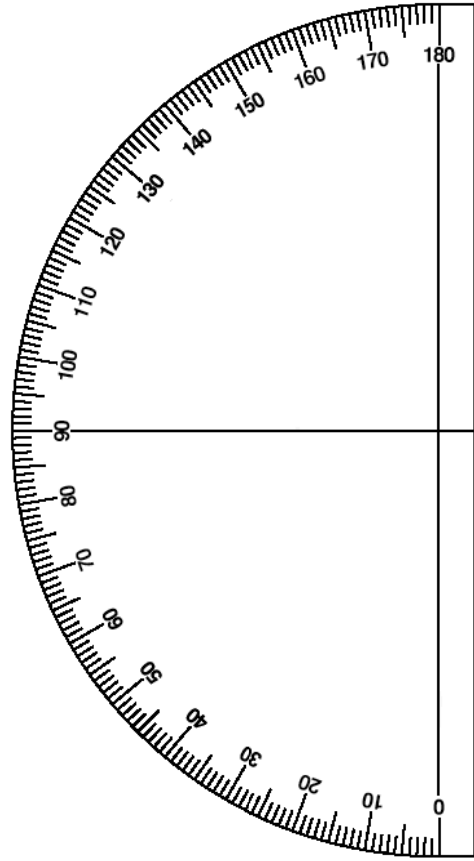
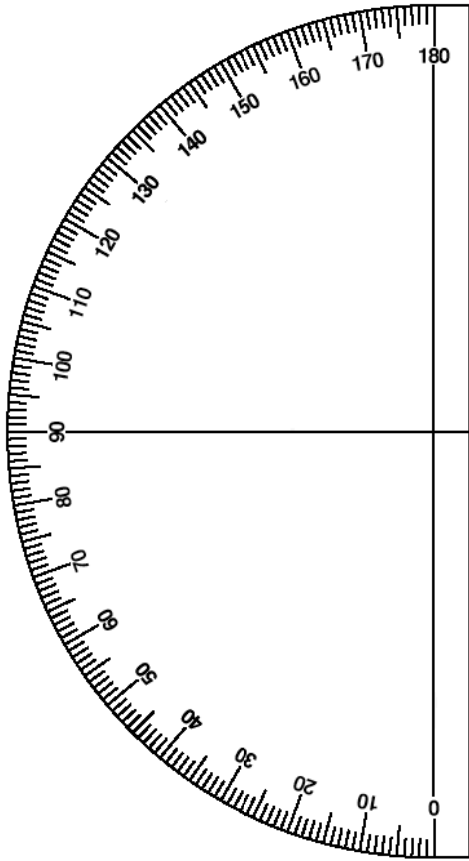

Rulers (6 inch)

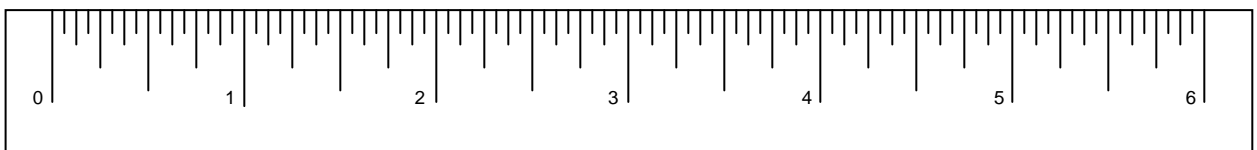
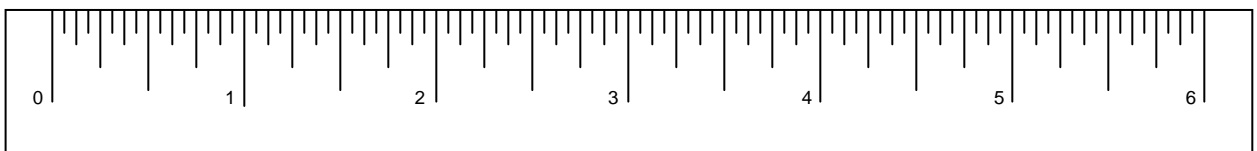
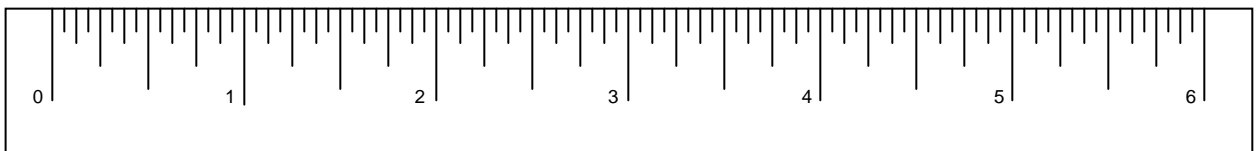
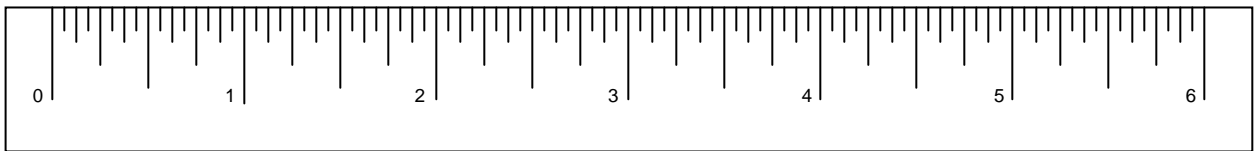
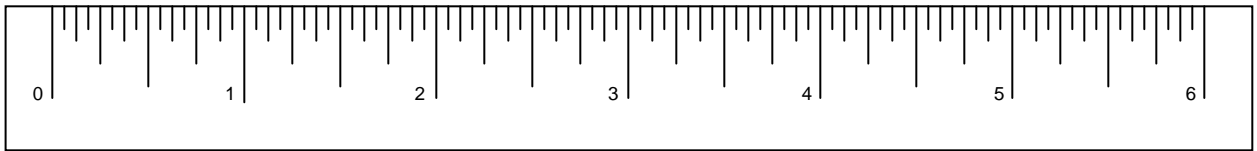
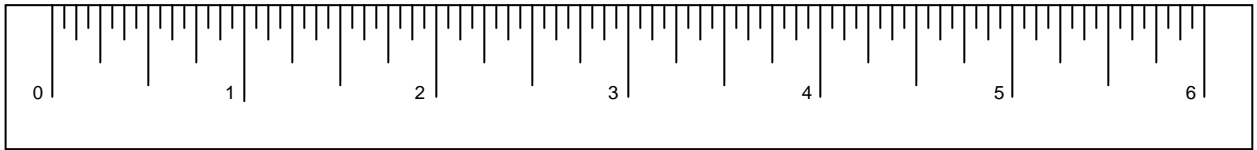
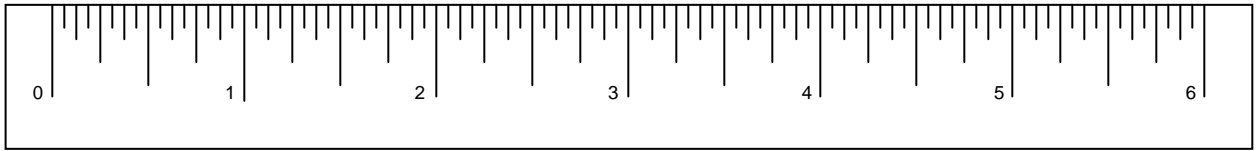
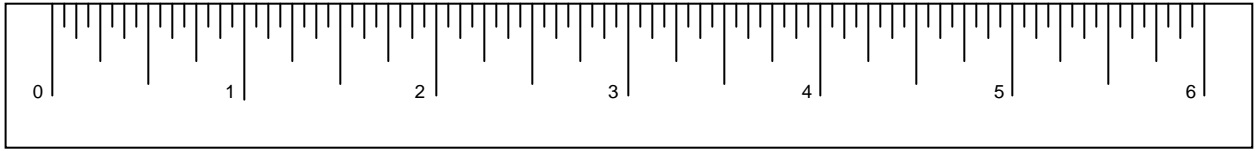

Rulers (15 cm)

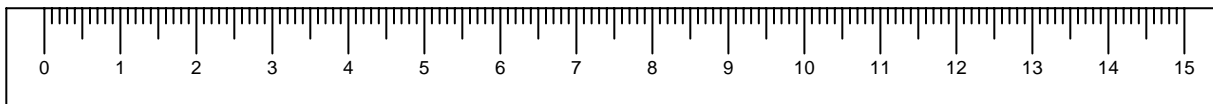
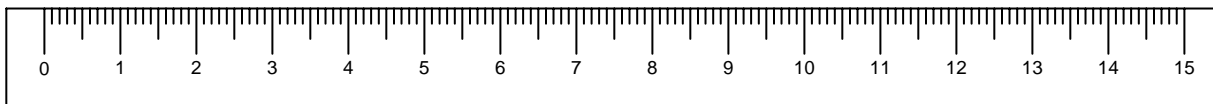
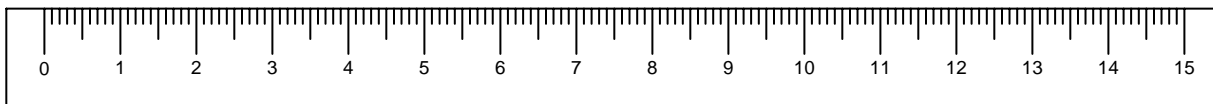
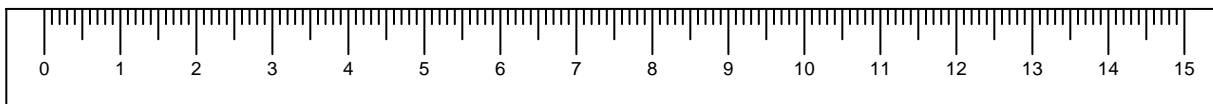
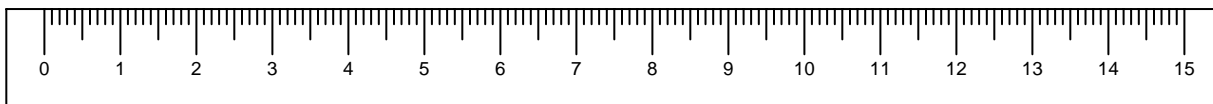
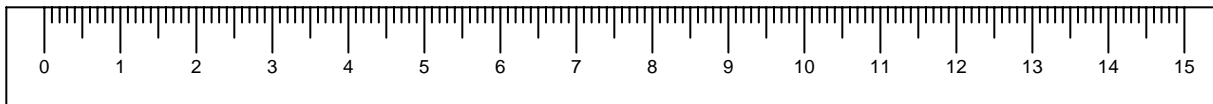
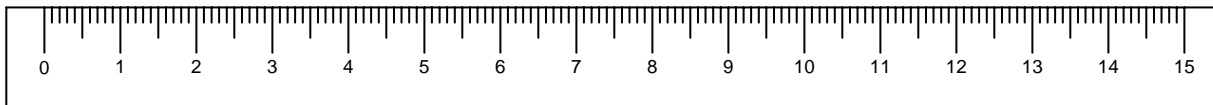
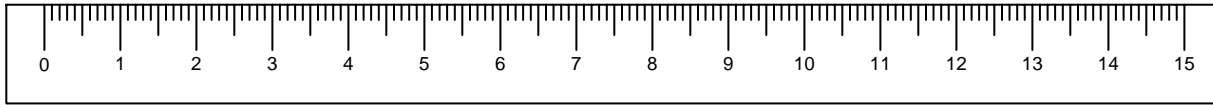
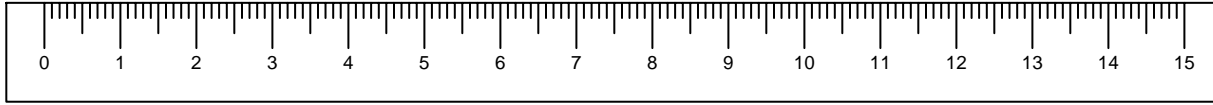
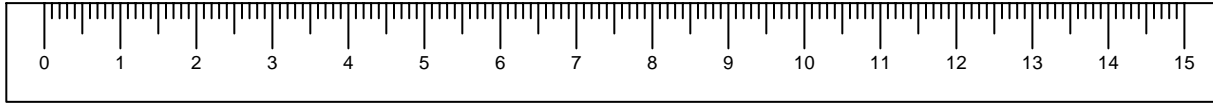

Bar Graph

Graph title: _____

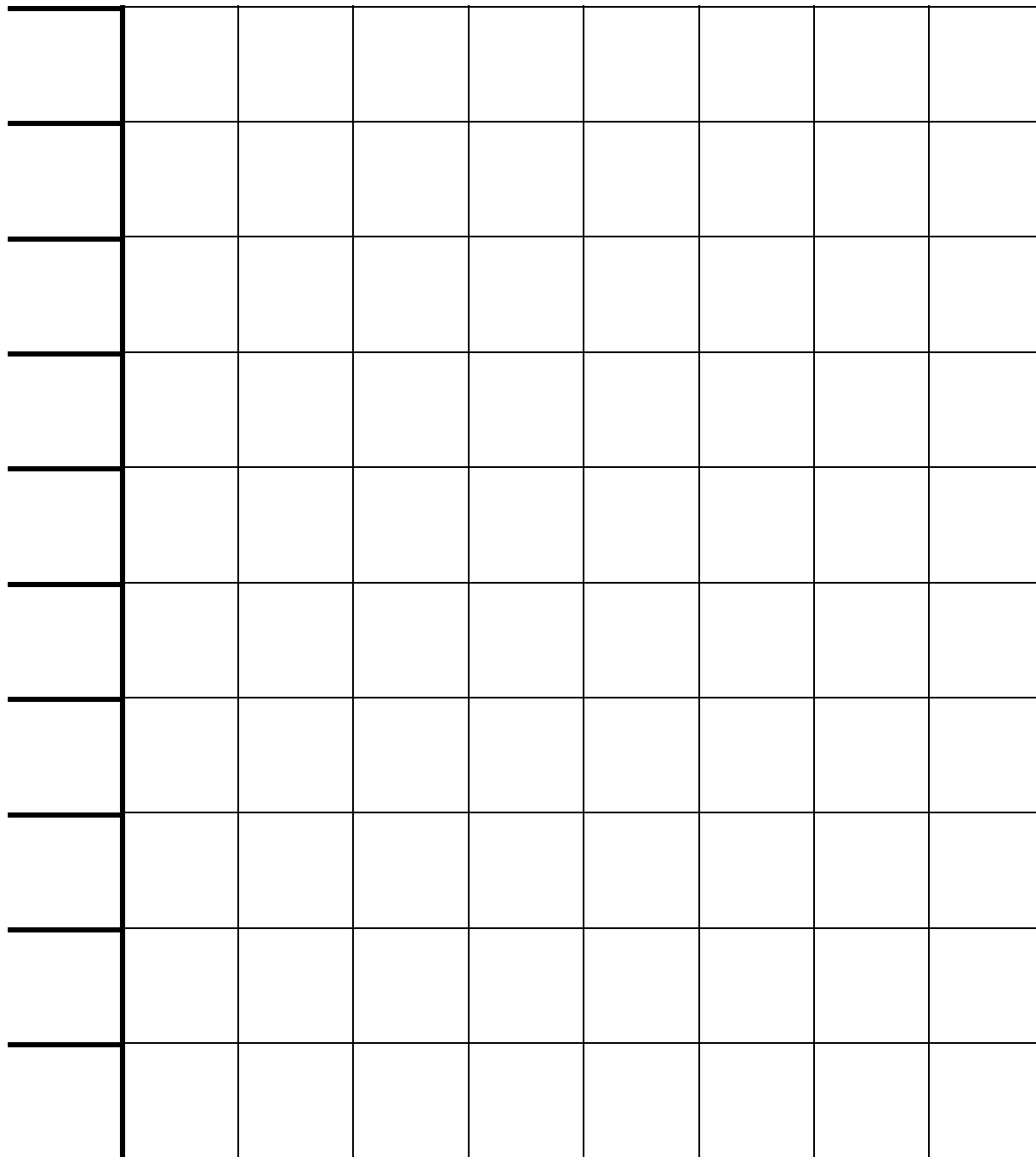

Hundredths Disk

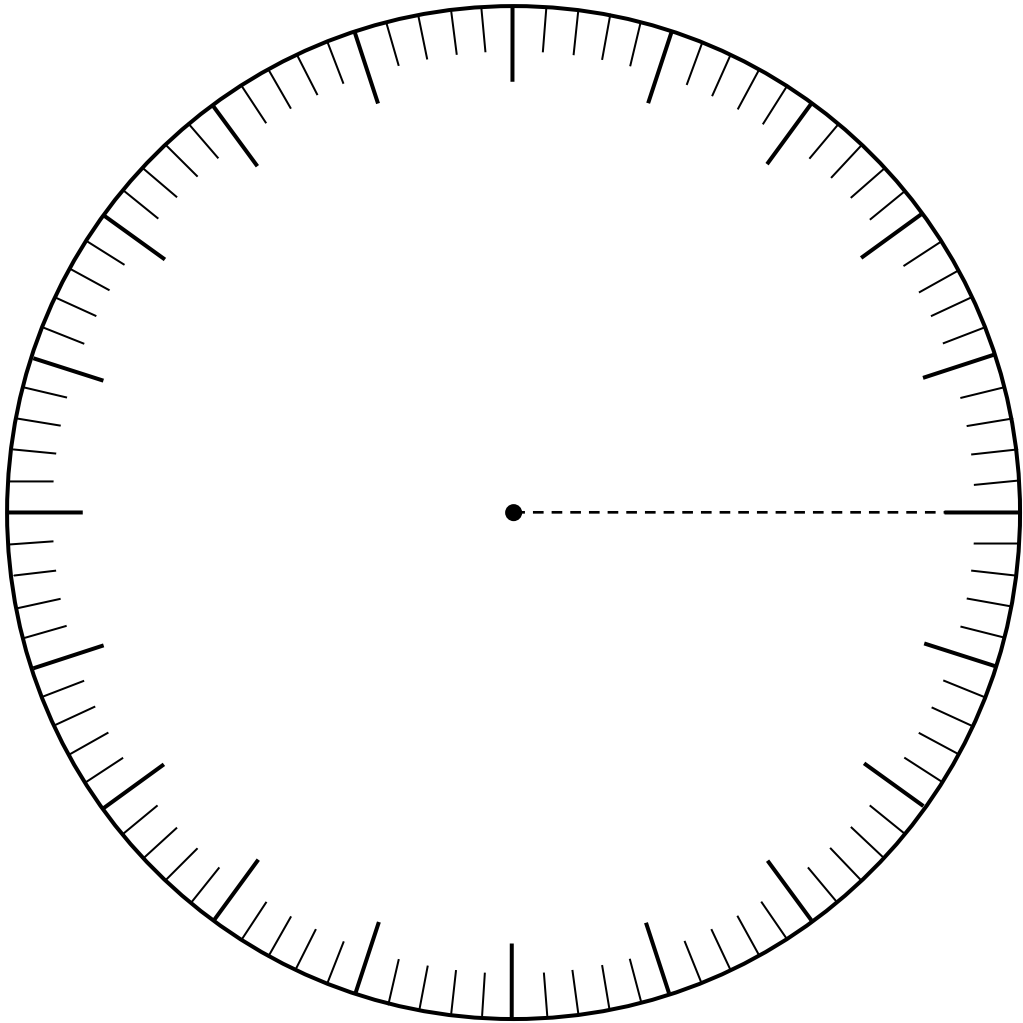

Canadian Currency (bills)



Canadian Currency (coins 1)



Canadian Currency (coins 2)



Canadian Currency (coins 3)



Coin designs courtesy of the Royal Canadian Mint / Images courtoisie de la Monnaie royale canadienne

Multiplication Chart (12 x 20)

1	2	3	4	5	6	7	8	9	10	11	12	13	14	15	16	17	18	19	20
2	4	6	8	10	12	14	16	18	20	22	24	26	28	30	32	34	36	38	40
3	6	9	12	15	18	21	24	27	30	33	36	39	42	45	48	51	54	57	60
4	8	12	16	20	24	28	32	36	40	44	48	52	56	60	64	68	72	76	80
5	10	15	20	25	30	35	40	45	50	55	60	65	70	75	80	85	90	95	100
6	12	18	24	30	36	42	48	54	60	66	72	78	84	90	96	102	108	114	120
7	14	21	28	35	42	49	56	63	70	77	84	91	98	105	112	119	126	133	140
8	16	24	32	40	48	56	64	72	80	88	96	104	112	120	128	136	144	152	160
9	18	27	36	45	54	63	72	81	90	99	108	117	126	135	144	153	162	171	180
10	20	30	40	50	60	70	80	90	100	110	120	130	140	150	160	170	180	190	200
11	22	33	44	55	66	77	88	99	110	121	132	143	154	165	176	187	198	209	220
12	24	36	48	60	72	84	96	108	120	132	144	156	168	180	192	204	216	228	240

Multiplication Chart (12 x 20)

1	2	3	4	5	6	7	8	9	10	11	12	13	14	15	16	17	18	19	20
2	4	6	8	10	12	14	16	18	20	22	24	26	28	30	32	34	36	38	40
3	6	9	12	15	18	21	24	27	30	33	36	39	42	45	48	51	54	57	60
4	8	12	16	20	24	28	32	36	40	44	48	52	56	60	64	68	72	76	80
5	10	15	20	25	30	35	40	45	50	55	60	65	70	75	80	85	90	95	100
6	12	18	24	30	36	42	48	54	60	66	72	78	84	90	96	102	108	114	120
7	14	21	28	35	42	49	56	63	70	77	84	91	98	105	112	119	126	133	140
8	16	24	32	40	48	56	64	72	80	88	96	104	112	120	128	136	144	152	160
9	18	27	36	45	54	63	72	81	90	99	108	117	126	135	144	153	162	171	180
10	20	30	40	50	60	70	80	90	100	110	120	130	140	150	160	170	180	190	200
11	22	33	44	55	66	77	88	99	110	121	132	143	154	165	176	187	198	209	220
12	24	36	48	60	72	84	96	108	120	132	144	156	168	180	192	204	216	228	240

Multiplication Chart (blank)

X	1	2	3	4	5	6	7	8	9	10
1										
2										
3										
4										
5										
6										
7										
8										
9										
10										

Multiplication Chart (fill in)

X	1	2	3	4	5	6	7	8	9	10
1		2		4		6	7	8	9	10
2	2	4			10	12	14			
3	3		9	12	15	18	21			
4		8	12		20		28			
5		10		20			35	40		
6	6		18	24	30	36	42	48	54	
7	7	14	21	28	35	42	49		63	70
8	8		24	32	40	48		64		80
9	9	18		36	45	54		72	81	90
10	10	20	30	40	50	60		80	90	100

Multiplication Chart (missing number 1)

X	10	8	6	2	7	4	3	5	1	9
1	10		6		7	4	3	5		9
2		16		4	14	8			10	18
3		24			21	12	9	15	3	27
4	40		24		28	16	12		4	
5	50	40	30	10		20	15	25	5	45
6	60	48		12	42		18		6	54
7	70			14	49	28	21		7	63
8	80		48	16	56			40	8	
9		72		18		36				81
10	100	80	60			40	30		10	90

Multiplication Chart (missing number 2)

X	10	8	6	2	7	4	3	5	1	9
5			30		35			25	5	45
4	40	32	24					20		
8	80	64	48	16	56	32	24	40	8	72
7			42	14	49	28		35	7	63
1	10	8	6			4		5	1	
2	20	16	12	4	14	8	6	10	2	18
6	60	48				24	18	30		
9		72	54		63		27	45	9	
3	30	24	18		21	12	9		3	
10	100	80	60		70	40		50		90

Number Cube (blank)

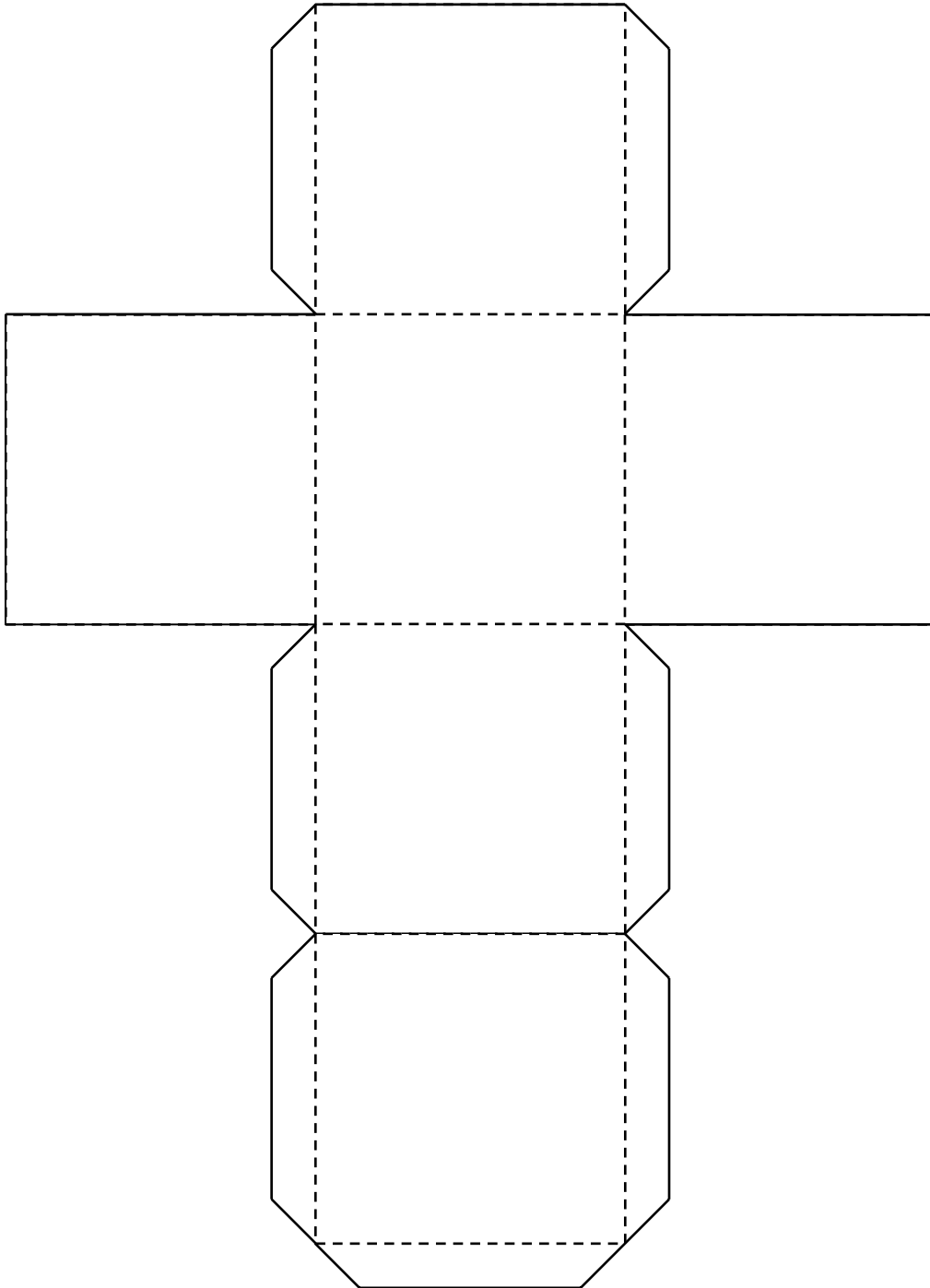

Number Cube (dots)

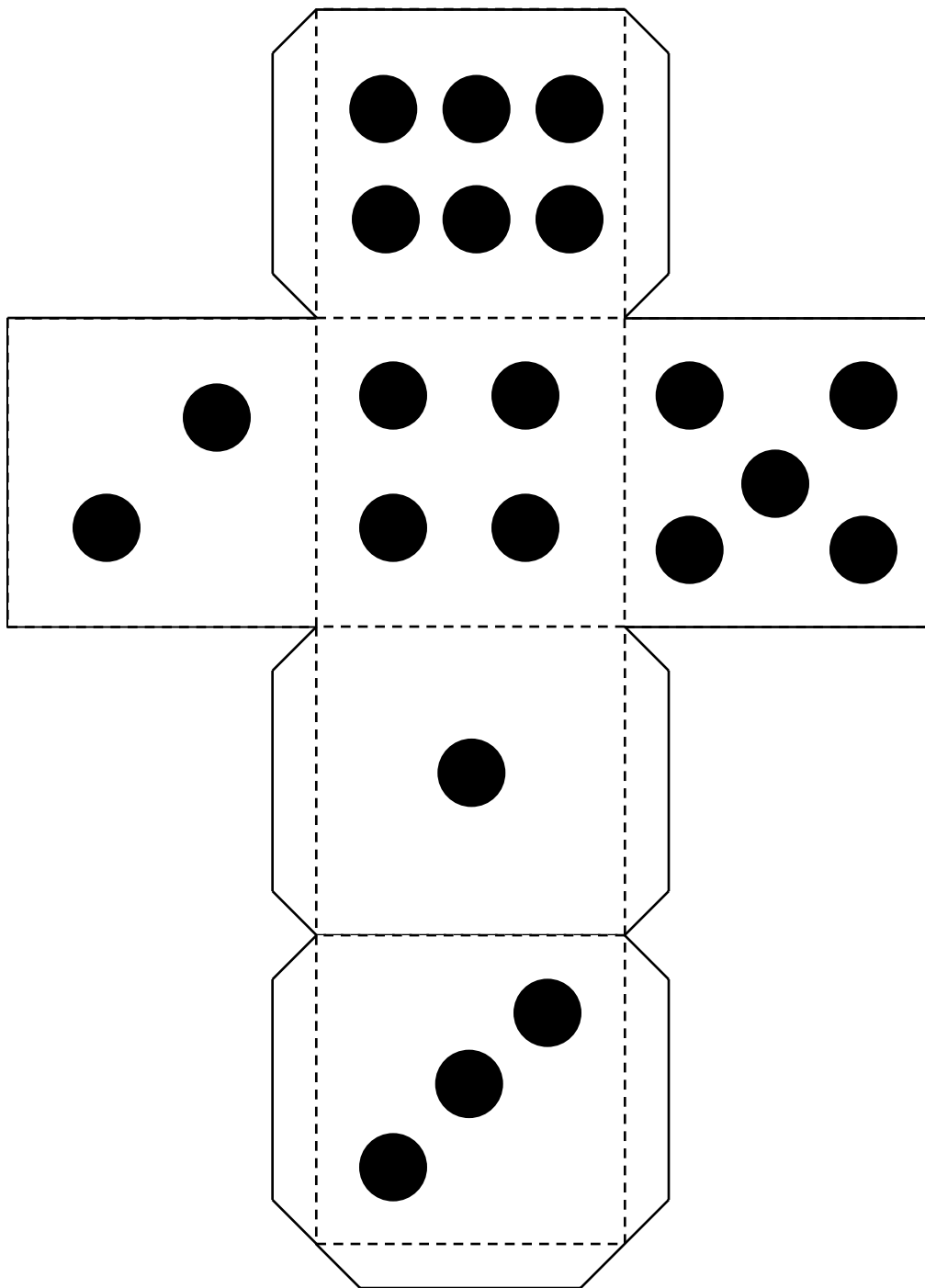

Number Cube (numbers)

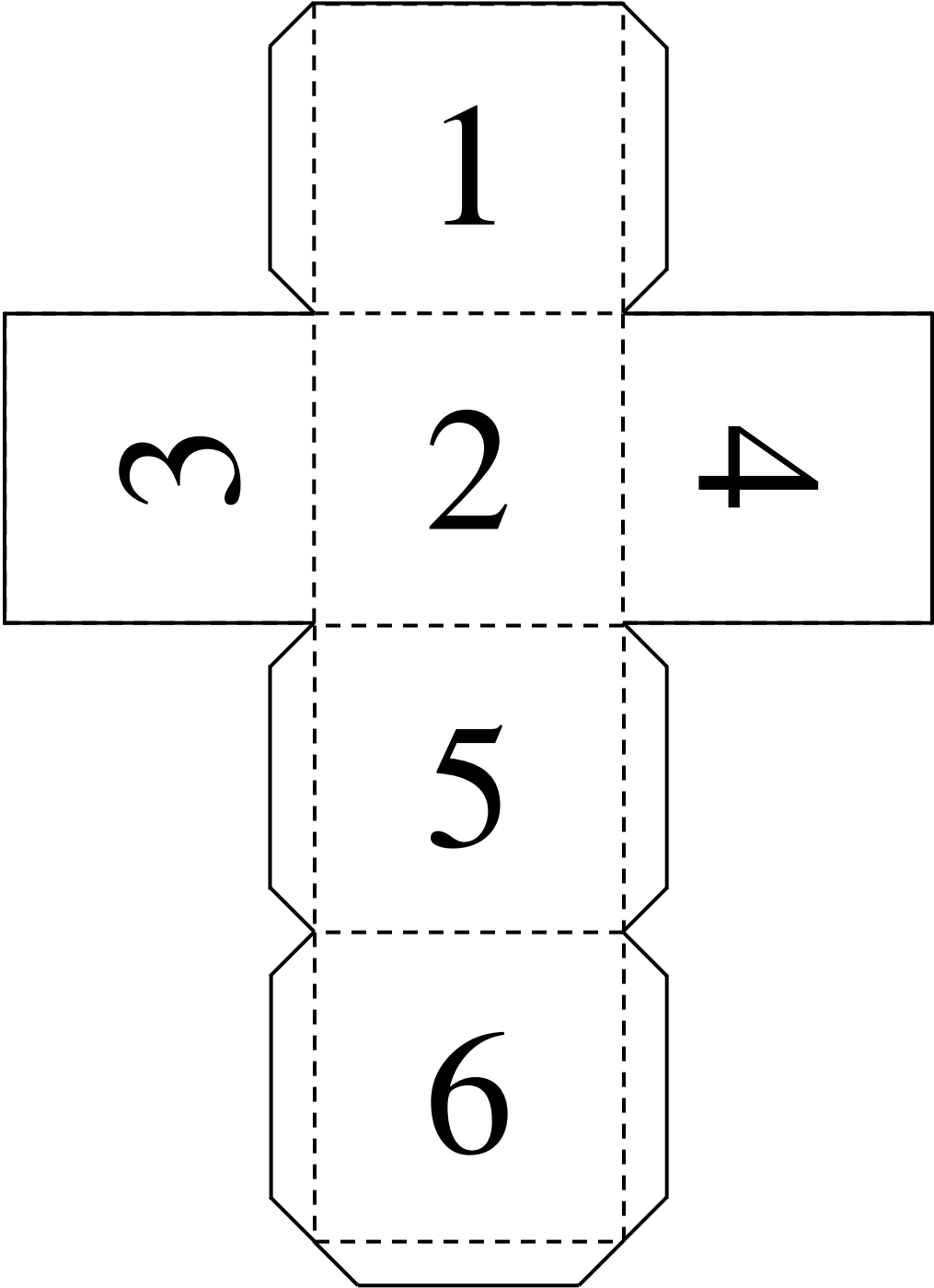

Fraction Number Lines (sixteenths)

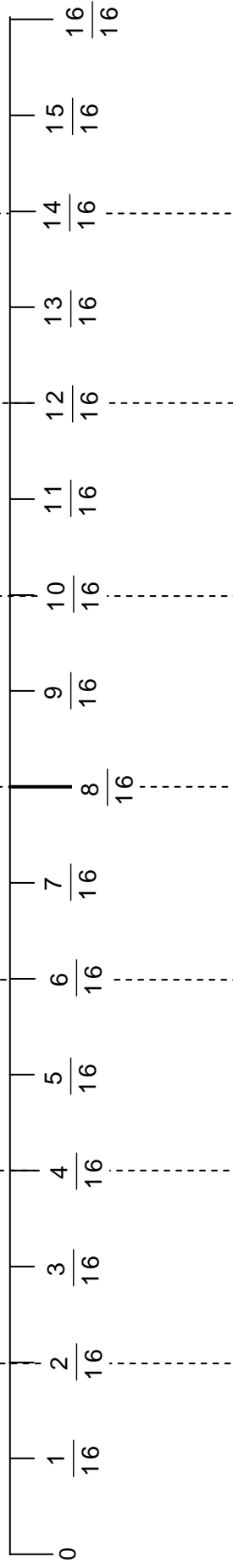
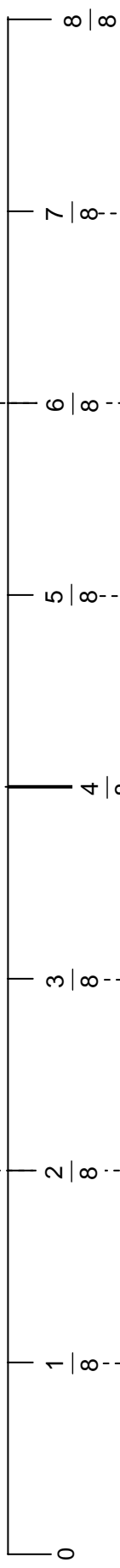
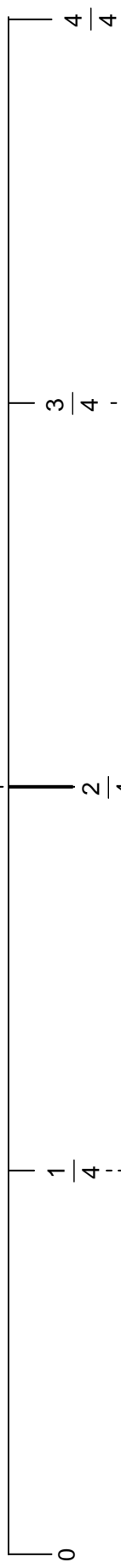
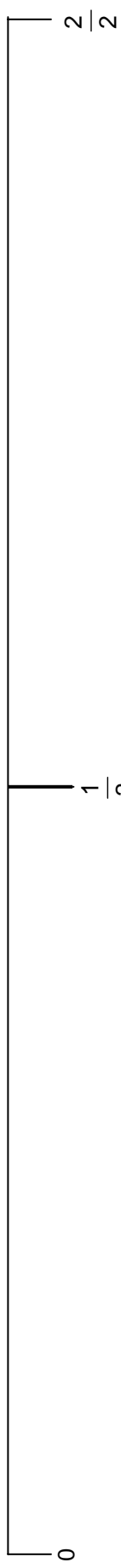

Fraction Number Lines (tenths)

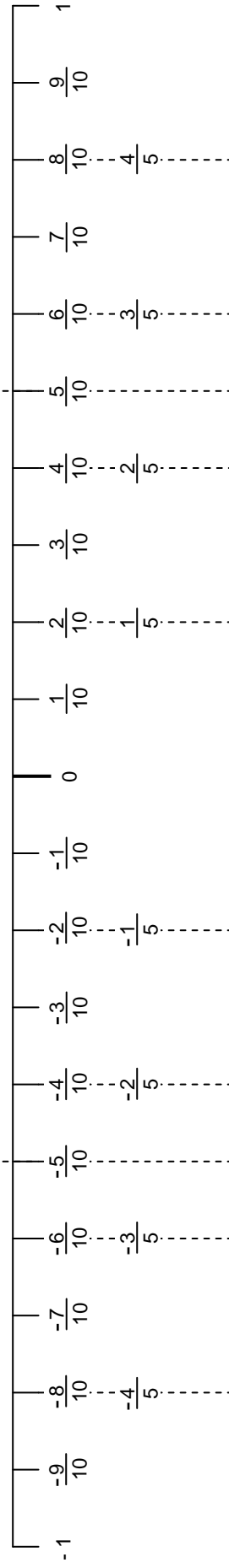
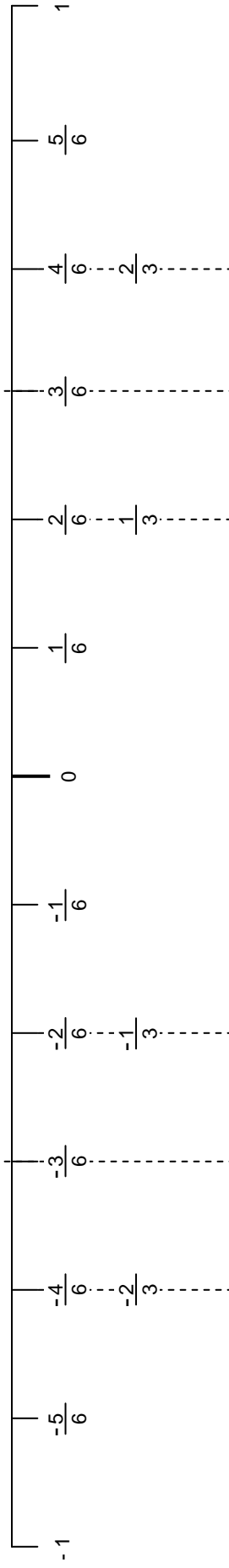
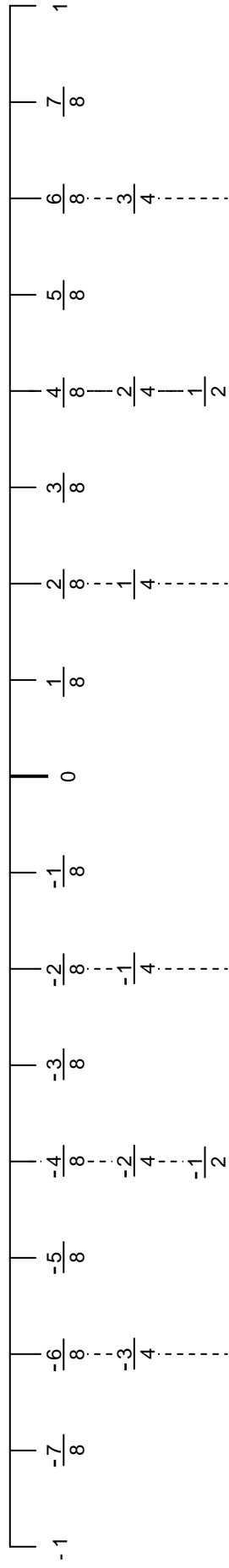

Fraction Number Lines (twelfths)

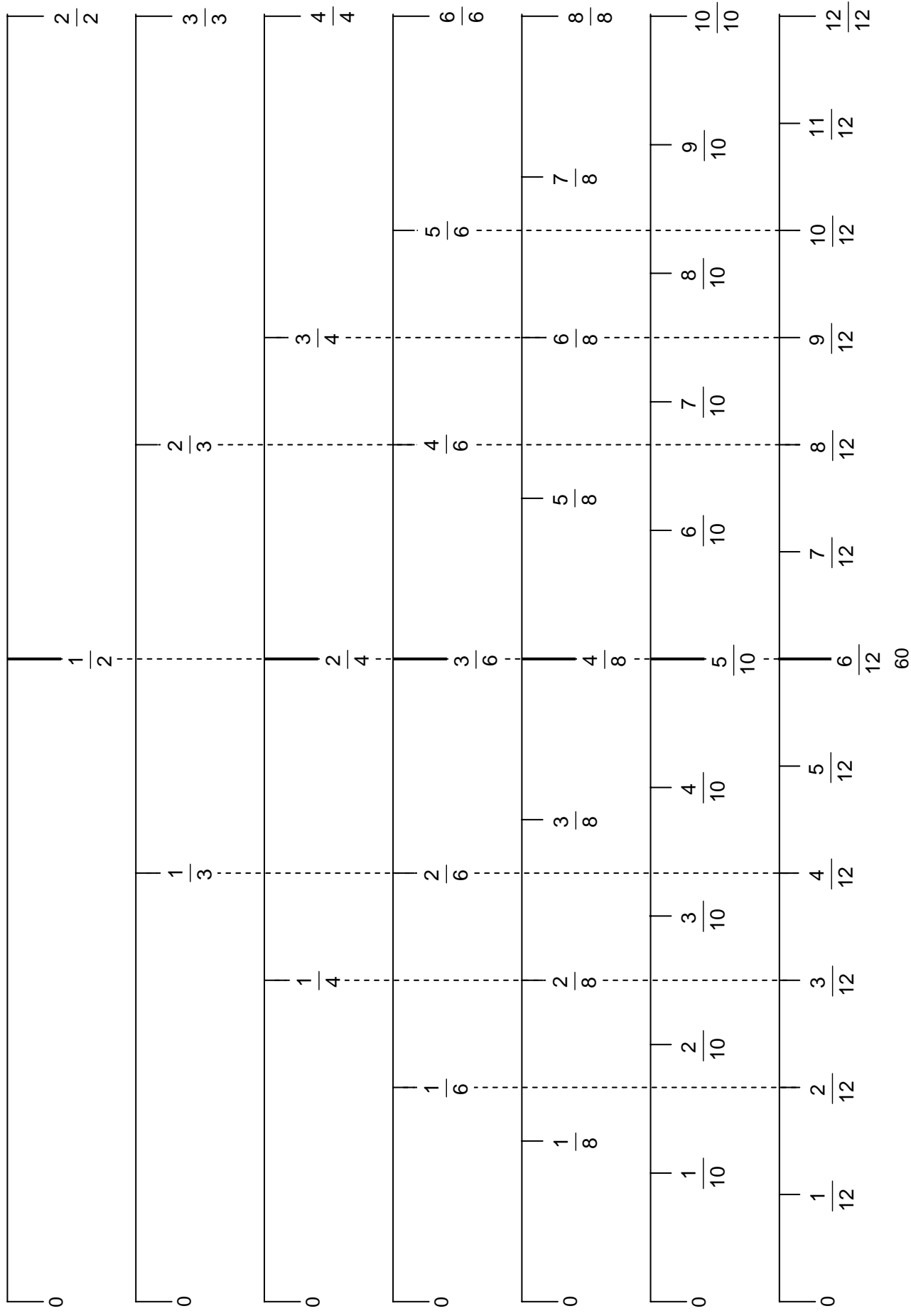

Number Line (vertical with -1, 0, +1)

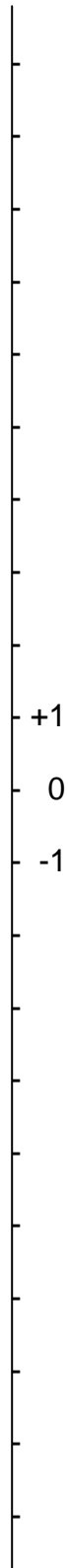

Number Line (vertical blank)



Number Line (vertical integers)

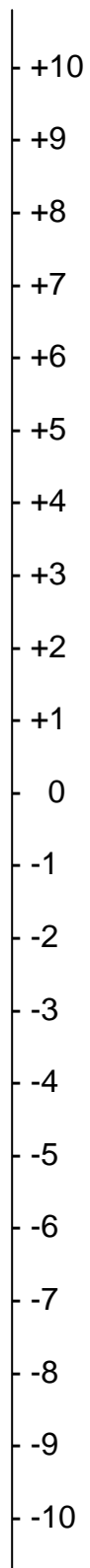

Number Lines (blank)



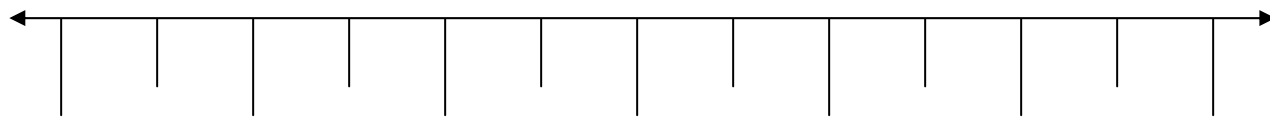
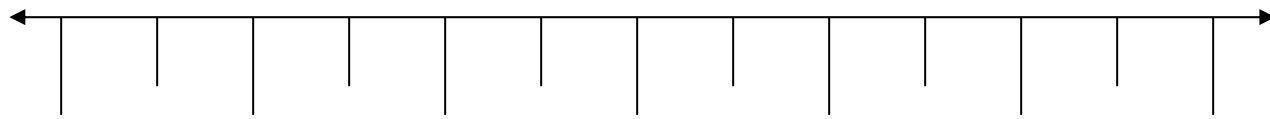
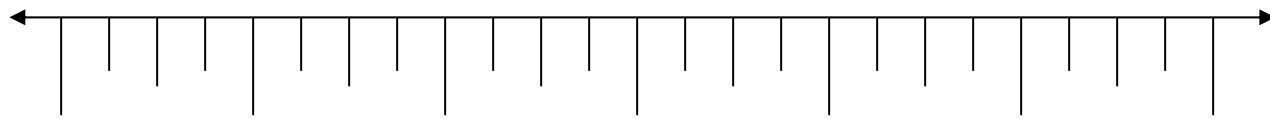
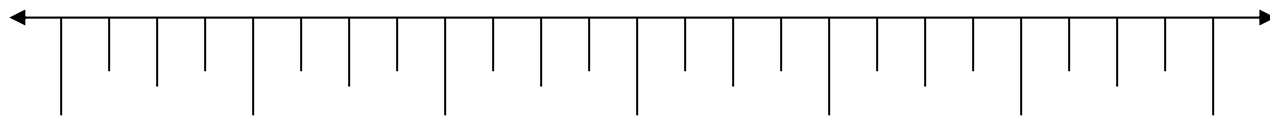
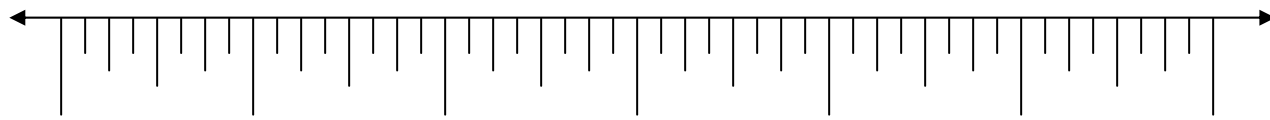
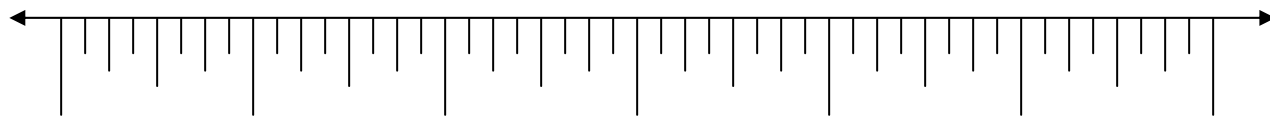
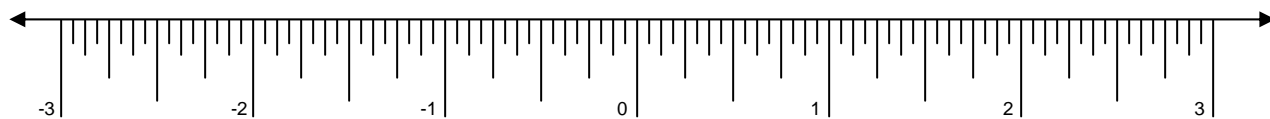
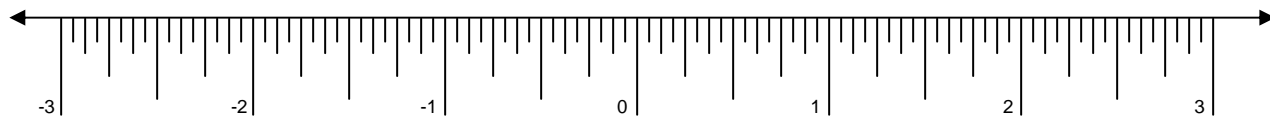

Number Lines (based on sixteenths)



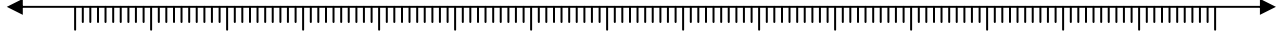
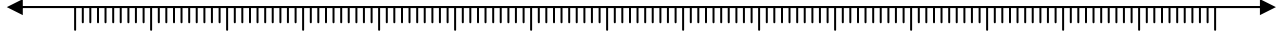
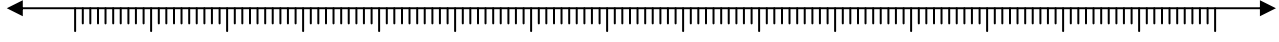
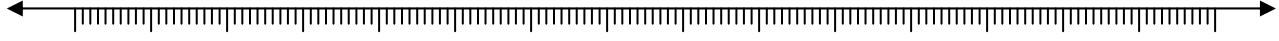
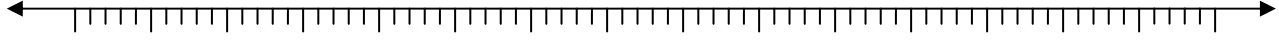
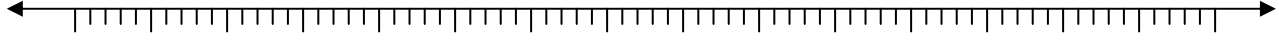
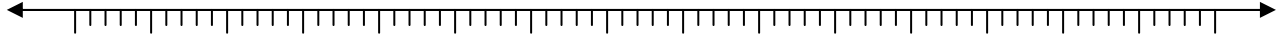
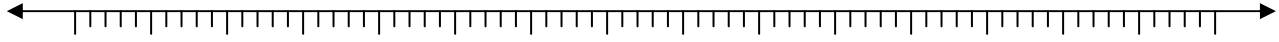
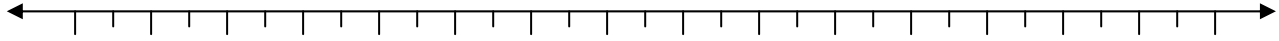
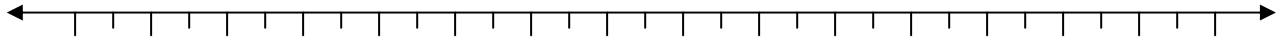
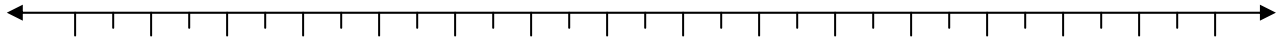
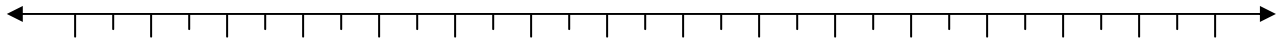
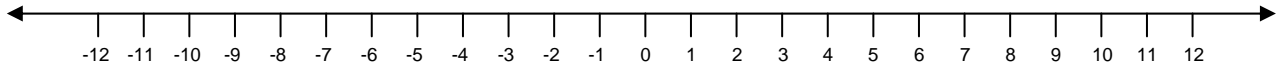
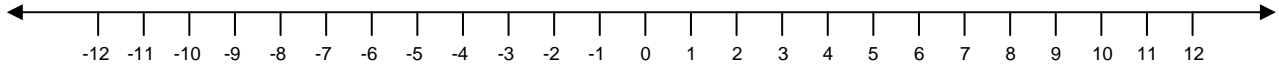
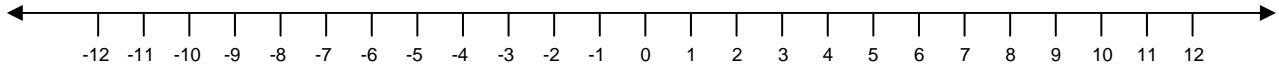
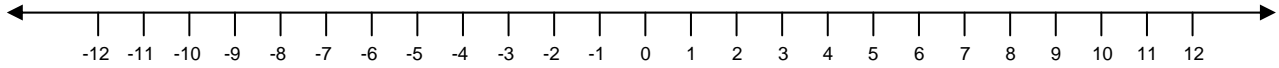

Number Lines (based on tenths)



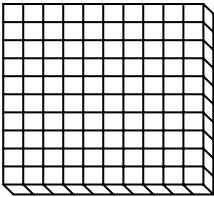
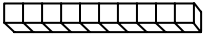

Place Value Chart (to tens)

Place Value Chart (to hundreds)

Place Value Chart (to thousands)

Place Value Chart (to hundred thousands)

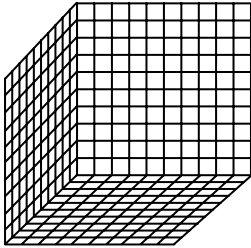
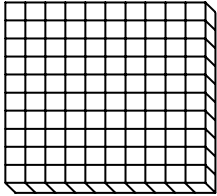
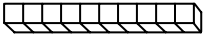
Thousands			Units		
H	T	O	H	T	O

Place Value Chart (to millions)

Millions			Thousands			Units		
H	T	O	H	T	O	H	T	O

Symmetry (bug)

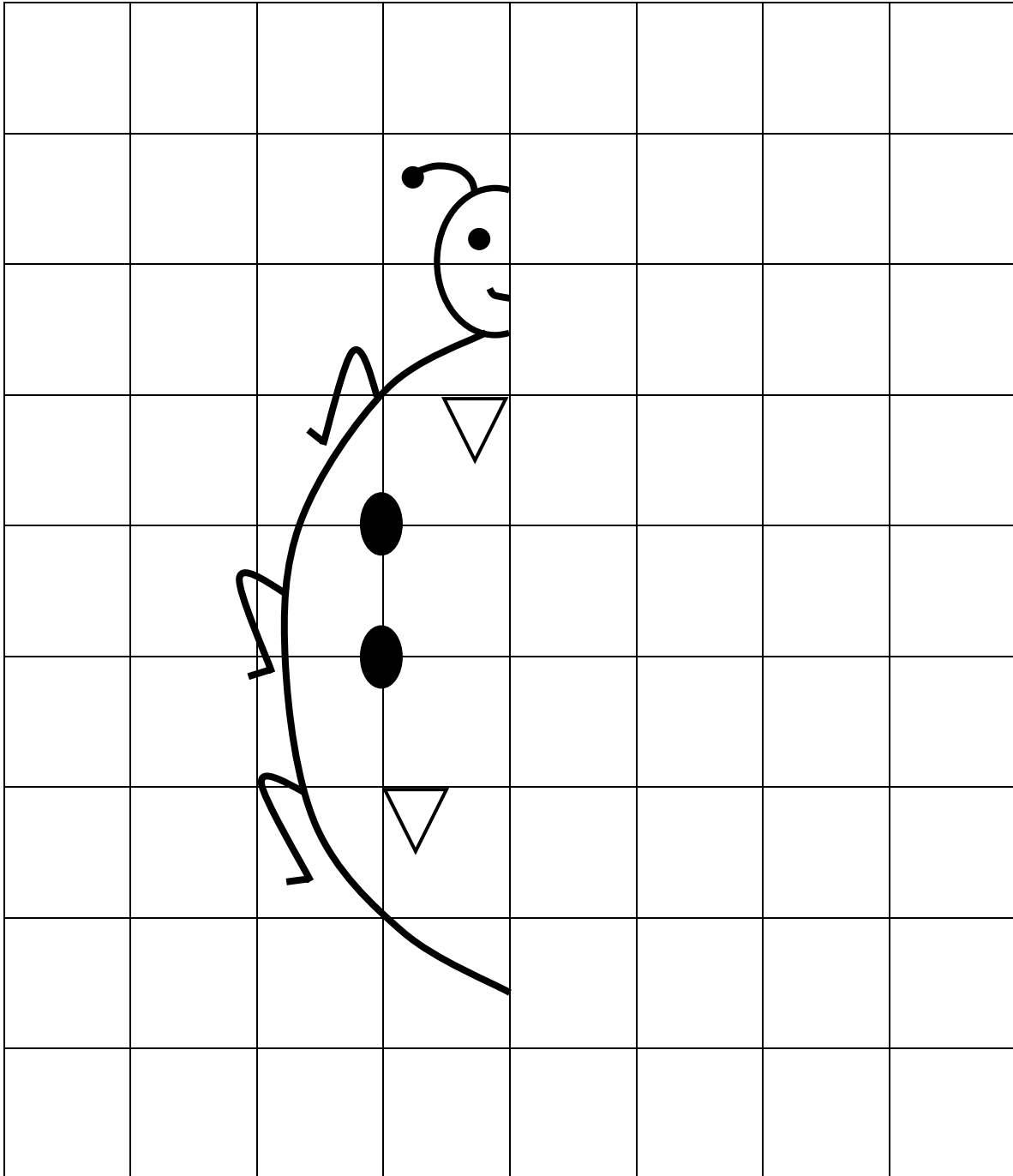

Symmetry (car)

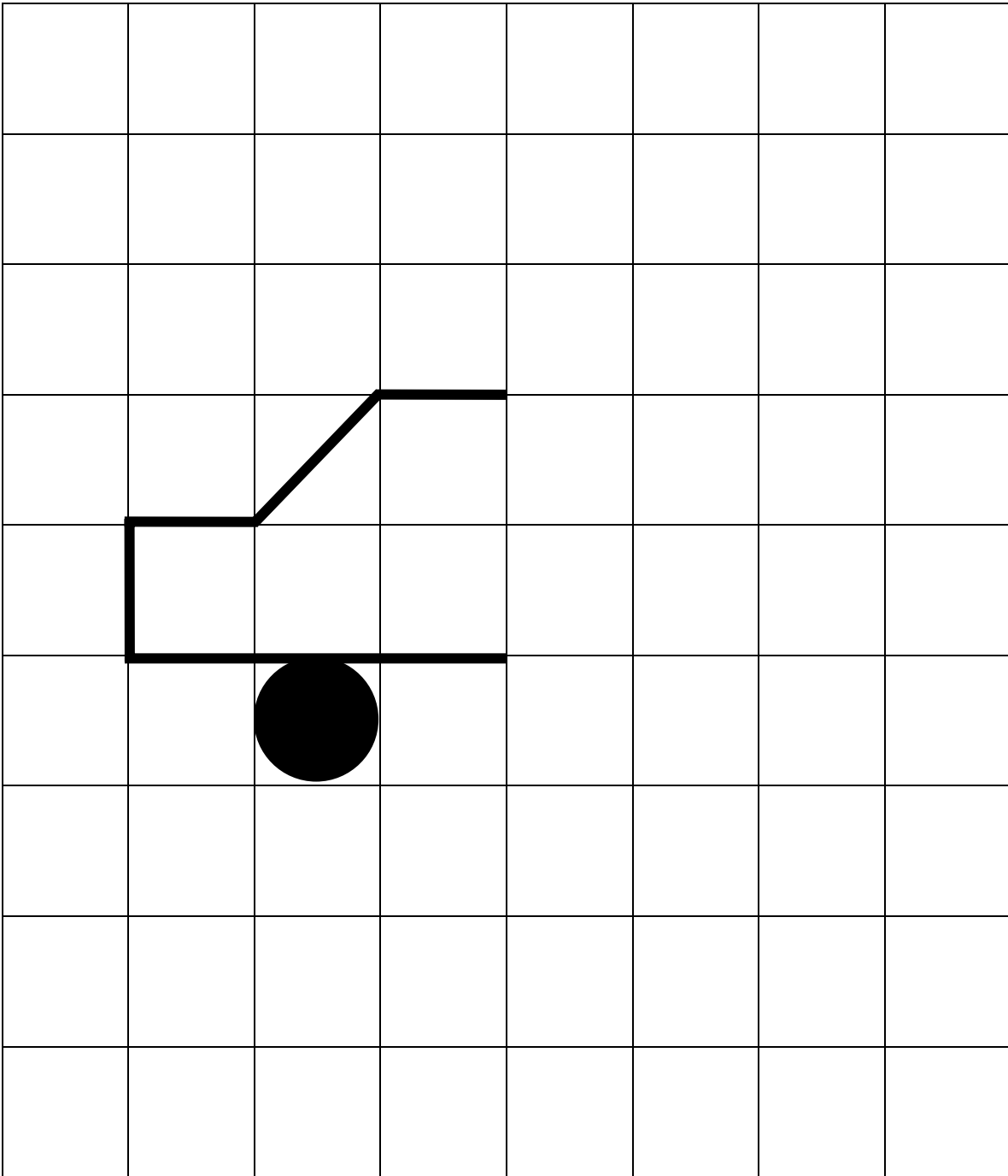

Symmetry (house)

